



# PAW5500-VES

Compact wall-mount  
evacuation systems

Models:

PAW5502-V

PAW5504-V

PAW5506-V



User manual

Cert. EN 54-16: 2008  
n° 0068/CPR/101-2018



### WARRANTY

This product is warranted to be free from defects in raw materials and assembly. The warranty period is governed by the applicable provisions of law. **PASO** will repair the product covered by this warranty free of charge if it is faulty, provided the defect has occurred during normal use. The warranty does not cover products that are improperly used or installed, mechanically damaged or damaged by liquids or the weather. If the product is found to be faulty, it must be sent to Paso free of charges for shipment and return. This warranty does not include any others, either explicit or implicit, and does not cover consequential damage to property or personal injury. For further information concerning the warranty contact your local **PASO** distributor.

**Important!** Before using the equipment, make yourself aware of all characteristics by reading carefully the instructions included in the printed manual or on the CD, paying particular attention to the safety notes.

**MODEL:** .....

**SERIAL NUMBER:** .....

**PURCHASE DATE:**.....

All **PASO** equipment is manufactured in accordance with the most stringent international safety standards and in compliance with European Community requisites. In order to use the equipment correctly and effectively, it is important to be aware of all its characteristics by reading these instructions and in particular the safety notes carefully.

**TABLE OF CONTENTS**

<b>1. WARNINGS</b>	4
1.1 Power supply and earthing	4
1.2 Safety notes	4
<b>2. INTRODUCTION</b>	5
2.1 Overview of the system	5
2.2 Functional features	5
2.3 Typical configuration	6
<b>3. GENERAL DESCRIPTION</b>	7
3.1 Front panel	7
3.2 Inside view	8
<b>4. INSTALLATION AND CONNECTIONS</b>	9
4.1 Wall mounting	9
4.2 Connections	10
4.2.1 Connection of emergency units	11
4.2.2 Connection of paging units	11
4.2.3 Connection to other PAW5500-VES units	12
4.2.4 Connection of auxiliary input	12
4.2.5 Connection of music input	13
4.2.6 Connection of input contacts	13
4.2.7 Connection of relay outputs	14
4.2.8 21 to 29V connection	14
4.2.9 Connection of loudspeaker lines	14
4.2.10 Connection of standby amplifier	15
4.2.11 Connection of power supplies	17
<b>5. OPERATIONAL CONDITIONS AND TERMINOLOGY</b>	18
5.1. Signalling of operating conditions	18
<b>6. DEFINITIONS</b>	18
<b>7. MENU STRUCTURE</b>	19
<b>8. USING THE SYSTEM</b>	20
8.1. Configuration of the system	21
8.2. < MUSIC > Menu	25
8.3. < AUDIO SETTING > Menu	26
8.4. < INSPECTION > Menu	29
8.5. < OPERATOR > Menu	32
8.6. < CONFIGURATION > Menu	35
8.7. Criteria for managing priorities in emergency conditions	43
8.8. MANUAL emergency – < EMERGENCY > Menu	44
8.9. AUTOMATIC emergency (alarm status activated by an external peripheral unit)	46
<b>9. FAILURE STATUS</b>	47
9.1. System operation and signalling in a generic failure condition	47
9.2. System operation and signalling with a fault on a loudspeaker line	47
<b>10. TECHNICAL SPECIFICATIONS</b>	48

## 1. WARNINGS

### 1.1 POWER SUPPLY AND EARTHING

These items of equipment are intended to work on a 230 VAC +10% / -15%, 50/60 Hz mains voltage and a 24 VDC supply from the internal batteries.

#### **!** N.B. – FEATURES OF THE WIRING SYSTEM

The mains AC power **MUST** be supplied through a two-pole differential thermal-magnetic circuit breaker with a current of 10 to 16A dedicated **SOLELY** to the equipment.

#### **!** N.B.

These devices have been designed to be connected to an earthed power supply.  
Make sure that the equipment is always connected to earth in accordance with legal regulations.

### 1.2 SAFETY NOTES

All **PASO** equipment is made according to the strictest international standards and complies with European Union requisites. For correct and effective use of the equipment it is important to be aware of all the characteristics by reading carefully these instructions and warnings. While the equipment is in use, it is necessary to ensure adequate ventilation, above all leaving the slits for providing air for the cooling fans free.

**REFER TO THE 'INSTALLATION AND CONNECTIONS' SECTION FOR THE RELEVANT PROCEDURES, TO BE CARRIED OUT BY TRAINED SPECIALISED PERSONNEL ONLY.**



#### **Important information for correct disposal of the product in accordance with EC Directive 2002/96/EC**

This product must not be disposed of as urban waste at the end of its working life. It must be taken to a special waste collection centre licensed by the local authorities or to a dealer providing this service. Separate disposal of electric and/or electronic equipment (WEEE) will avoid possible negative consequences for the environment and for health resulting from inappropriate disposal, and will enable the constituent materials to be recovered, with significant savings in energy and resources. As a reminder of the need to dispose of this equipment separately, the product is marked with a crossed-out wheeled dustbin.

 This product is in keeping with the relevant European Community Directives.

## 2. INTRODUCTION

### 2.1 OVERVIEW OF THE SYSTEM

The new **PAW5500-VES** range includes three integrated voice evacuation systems for emergency facilities, designed specifically for wall-mounting and equipped with control units, certified in compliance with **EN 54-16:2008 / EN 54-4** standards. Depending on the model, these systems are capable of managing from 2 to 6 alarm zones, each driven by a single amplifier, as well as remote microphone stations and controlled inputs to be connected to a central fire-fighting system. It is possible to connect up to a maximum of 6 of these systems to one other (for managing an overall maximum of 36 zones).

### 2.2 FUNCTIONAL FEATURES

- Rated audio output: 500 W overall, distributable freely among the zones with a maximum limit of 250 W per single zone.
- Backlit 4.3" display with touch screen for selecting the alert and evacuation zones and enabling navigation for adjusting volume levels, configuring the equipment and viewing failures.
- Handheld fireman's paging microphone.
- Sending out of pre-recorded EVACUATION and ALERT messages.
- Sending out of pre-recorded BROADCAST messages (i.e. spots, announcements, sound bells).
- Playing back of pre-recorded messages via monitor loudspeaker.
- 7 off controlled input contacts, configurable for playing the evacuation and/or alert messages to the programmed zones or for resetting the messages.
- 1 off music input for sound sources.
- 1 off auxiliary input configurable as a music source, a call with precedence activation or a call with automatic activation (VOX).
- 3 off configurable relay outputs.
- Double A+B output for each zone.
- Event log (list of failures and/or alarms that have occurred in the system).
- Double LINK line for connecting other **PAW5500-VES** (up to a total of 6 units).
- Multilanguages management.
- Protected local button for placing the system in an emergency state, equipped with its own LED.
- Local reset button.
- 3-band equalisation for each zone output.
- 3-band equalisation for each music input.
- Optional internal expansion card **ACPAW-2IN** for two additional music inputs (EXT 1 and EXT 2).
- Optional internal expansion card **ACPAW-6IN** with DSP for six additional music inputs.
- Built-in SD/USB input for background music MP3 player.
- Independent selection on each zone of the various audio sources (MUSIC IN, AUX IN, MP3 player and EXT).
- Up to 8 pre-recorded messages can be retrieved from outside through input contacts (of which 2 fixed emergency messages - plus 6 that can be classed as emergency / evacuation / broadcast messages).
- Possibility of setting up to 16 timers for the programmed playing out of the broadcast messages with the possible activation of signalling relays.
- Up to 16 **PMB106-G** and/or **PMB112-G** broadcasting microphone stations can be connected.
- Up to 4 of the above mentioned stations can be set for local calls only (zones of the card-cage to which they are connected).
- Up to 4 **PMB132-V** and **PMB132/12-V** remote emergency units can be connected (or, as an alternative, up to 2 touch screen units **TSB8500-V**).
- EN54-4 certified battery charge unit for 24VDC secondary power supply (batteries not included).
- Mounting on 19" rack (optional, with **ACPAW-RCK** accessory kit).

2.3 TYPICAL CONFIGURATION

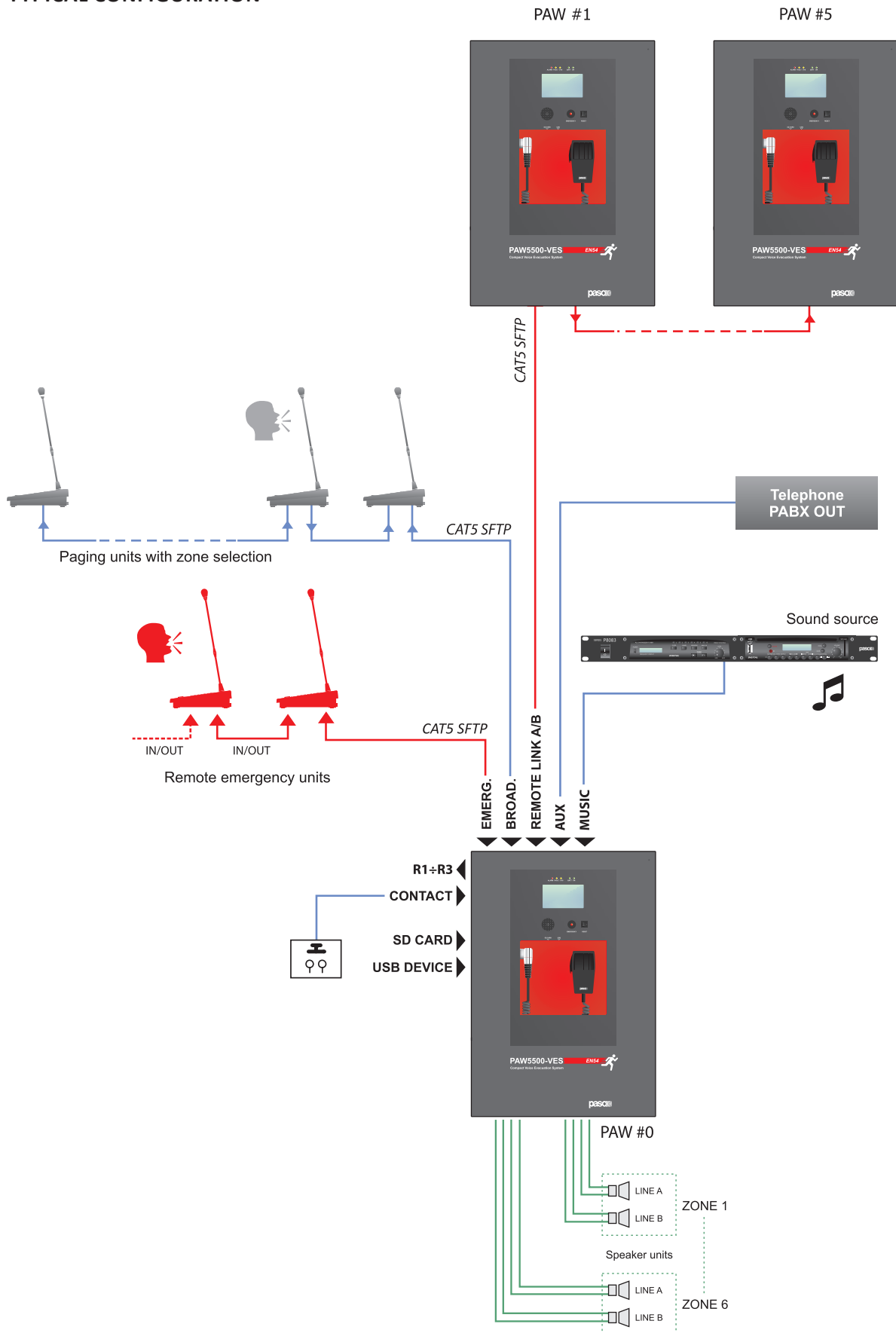

### 3. GENERAL DESCRIPTION

#### 3.1 FRONT PANEL

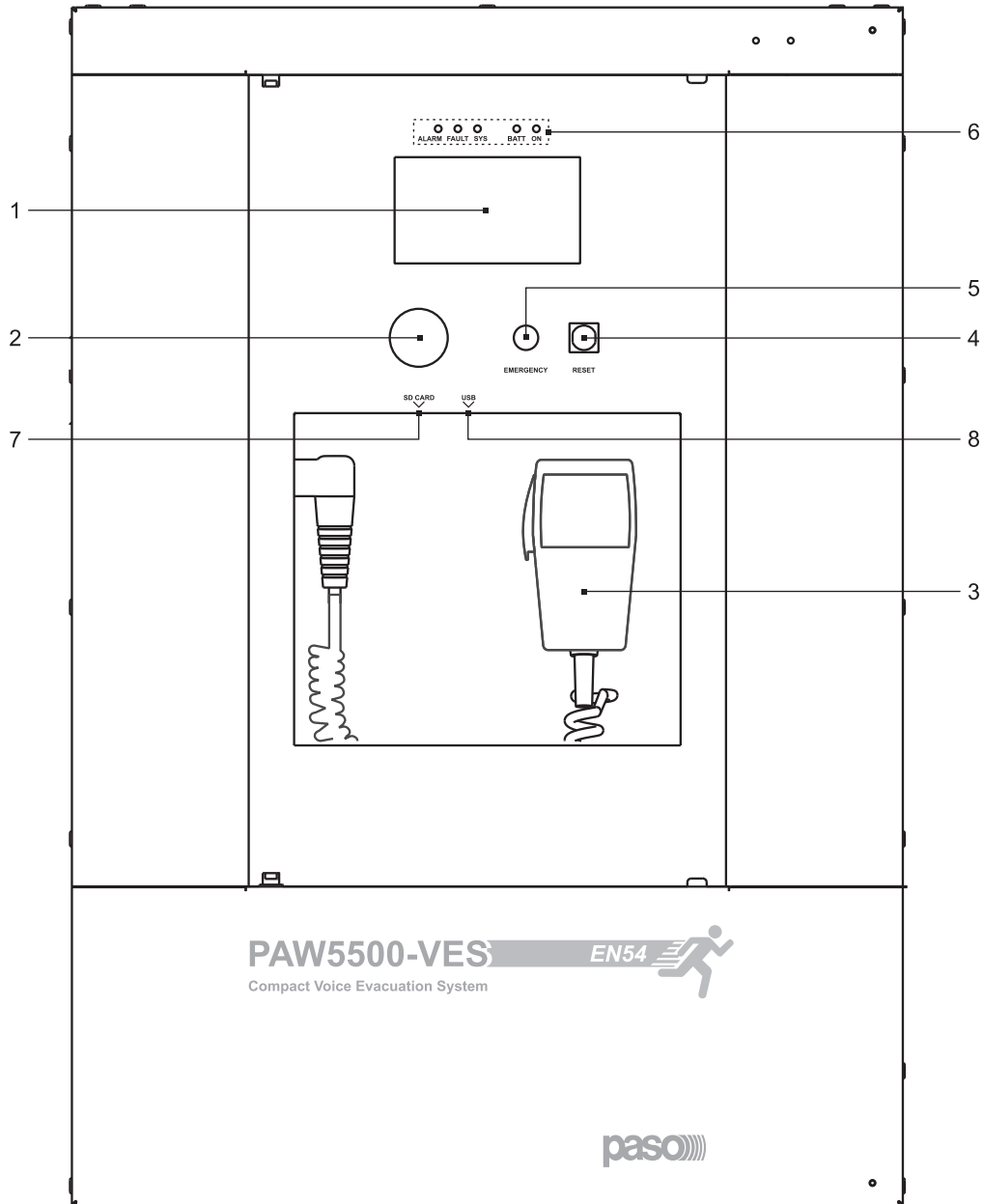

- 1) Backlit 4.3" display with touchscreen for selecting the Alert/Evacuation zones and for navigation for adjusting volume levels, configuring the equipment and viewing failures.
- 2) Integrated loudspeaker for playing back the output signals from the zones or the signals of the input sources and for replaying the acoustic signal indicating that a failure has been detected (beep). The signalling tone will be automatically muted if the conditions of failure end. Furthermore, in accordance with the regulations, the beep is muted by the system while the Emergency Microphone is being used.
- 3) Handheld fireman's paging microphone.
- 4) RESET button.
- 5) EMERGENCY button.
- 6) Status LEDs.
- 7) SD card slot.
- 8) USB socket for external device.

### 3.2 INSIDE VIEW

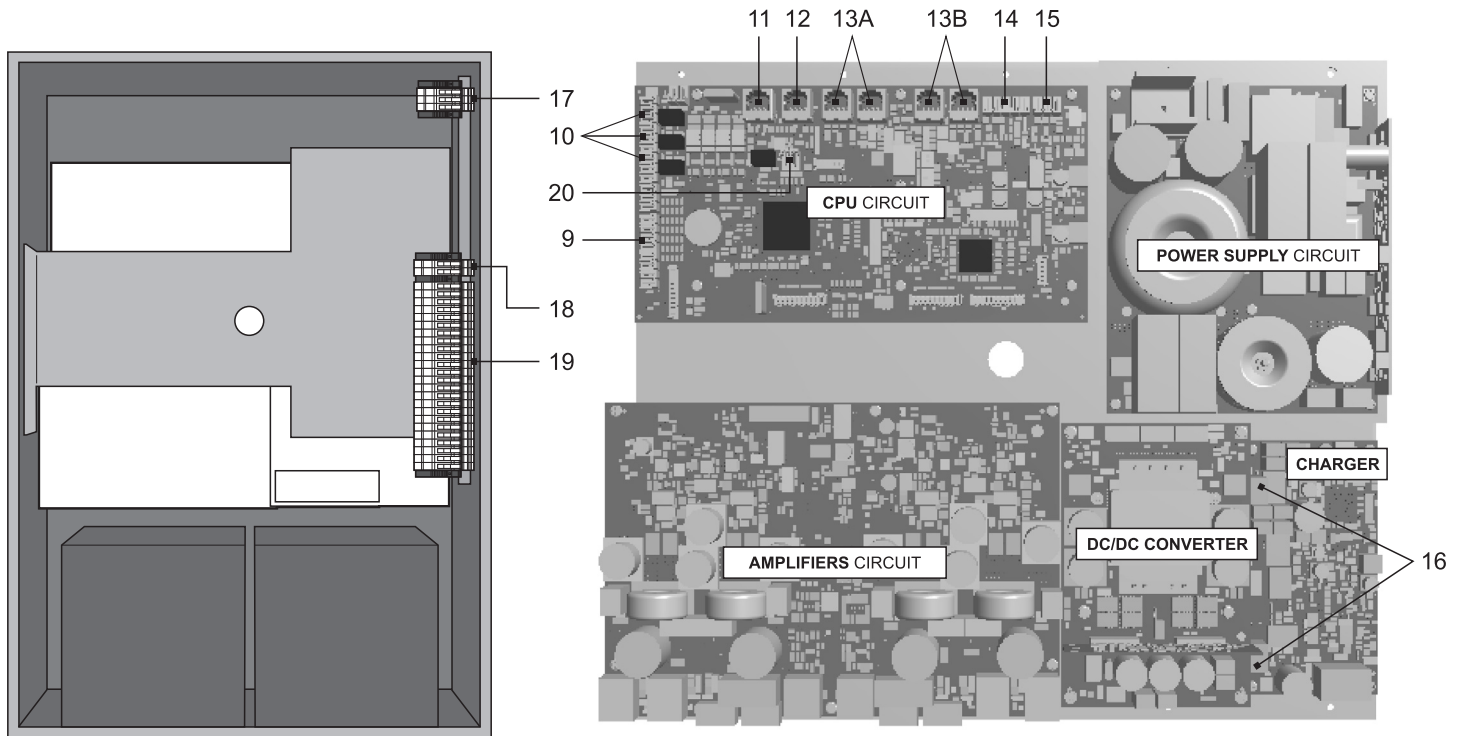

- 9) 7 off controlled input contacts.
- 10) 3 off relay output contacts.
- 11) Input for emergency microphone stations (max. 4).
- 12) Input for paging microphone stations (max. 16).
- 13) Input/output sockets REMOTE LINK A/B for connection to other **PAW5500-VES** units (overall max. of 6).
- 14) Input terminal strip for auxiliary sources with precedence contact.
- 15) Input terminal strip for music sources.
- 16) Connection to 24 VDC battery power.
- 17) Connection to 230 VAC power supply.
- 18) Connection of standby amplifier.
- 19) Connection of loudspeakers lines.
- 20) Terminal strip for 21 to 29 V connection.



## 4. INSTALLATION AND CONNECTIONS

### ! N.B.

Please remind that the operations illustrated in this part of the manual must be carried out by specialised personnel ONLY, trained and qualified in the equipment installation and maintenance. When the PAW is opened, parts entailing a high risk of electric shocks become accessible.

It is advisable to install the equipment in a closed and sheltered place, protected against possible sources of damage (rain, moisture, high temperatures, etc.).

Depending on requirements, the cables can be inserted by eliminating either the plugs sealing the holes in the top or the rear door (in both cases use a flat screwdriver or a cutter to lift them and remove them).

! It is important to keep the power cables separate from those dedicated to the other connections.

### 4.1 WALL MOUNTING

Take the cardboard template included in the package and position it at a suitable height so that it is accessible to the user. Ideally, the front display should be at eye level.

Having decided on the position, mark the five points on the wall and fit Fischer wall plugs (min. Ø 9 mm) equipped with bolts into them.

Using the wall plugs as reference pins, lift the equipment and hook it to the wall. It is advisable for this activity to be carried out by two people.

Tighten the bolts.

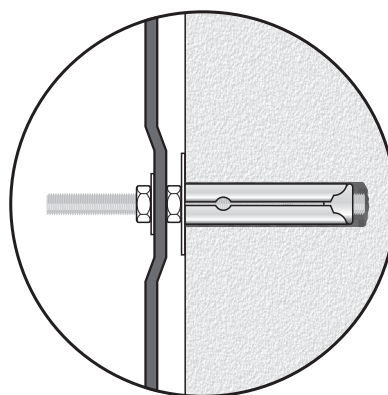
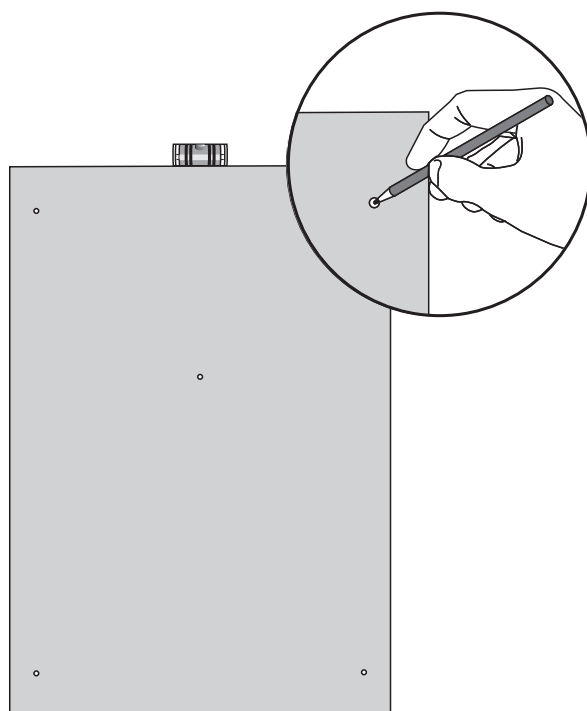
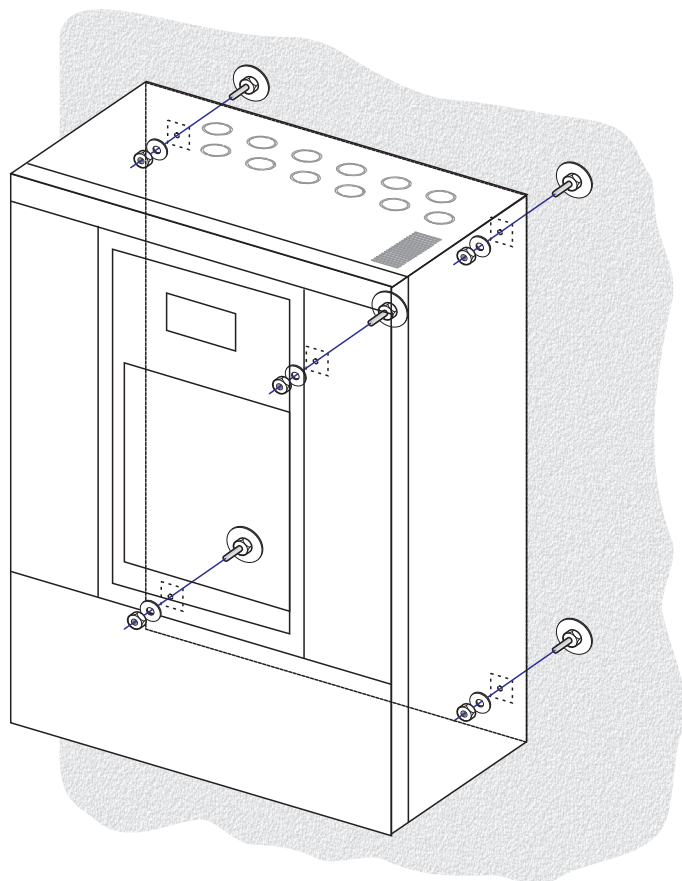

### NOTE:

For rack mounting, it is necessary to use the optional accessory **ACPAW-RCK** and to follow the indications provided on its instruction sheet.

## 4.2 CONNECTIONS

### ! N.B.

Check that the main thermal-magnetic circuit breaker is switched OFF.

If it is not, switch it OFF before carrying out any other activities in the cabinet as there is a danger of electric shocks.

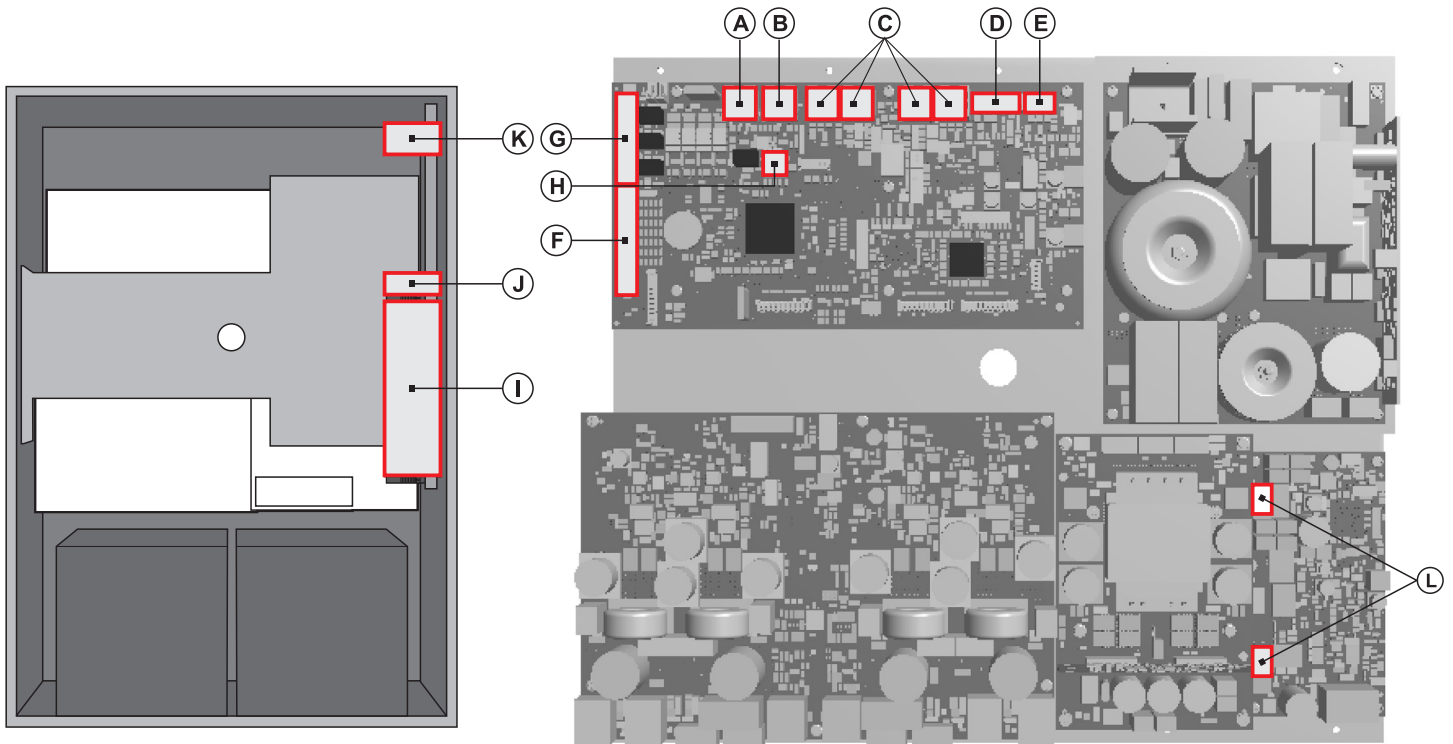

Proceed with connection of the various devices, referring to the appropriate points of the manual:

#### CPU circuit

A)	Point 4.2.1	Connection of emergency units	(page 11)
B)	Point 4.2.2	Connection of paging units	(page 11)
C)	Point 4.2.3	Connection to other PAW5500-VES systems	(page 12)
D)	Point 4.2.4	Connection of auxiliary input	(page 12)
E)	Point 4.2.5	Connection of music input	(page 13)
F)	Point 4.2.6	Connection of input contacts	(page 13)
G)	Point 4.2.7	Connection of relay outputs	(page 14)
H)	Point 4.2.8	21 to 29V connection	(page 14)

#### AMPLIFIER circuit

H)	Point 4.2.8	Connection of the loudspeaker lines	(page 14)
I)	Point 4.2.9	Connection of the standby amplifier	(page 15)

Once the basic connections have been made, it is possible to go on to connect the power supplies:

J/K)	Point 4.2.10	Connection of power supplies	(page 17)
------	--------------	------------------------------	-----------

### ! N.B.:

It is essential to follow the correct sequence for powering up the equipment, failing which it could be damaged.

4.2.1 CONNECTION OF EMERGENCY UNITS [CPU CIRCUIT]

Use a CAT. 5e SF/UTP cable for connecting the **EMERG.** socket (11) to the 'IN/OUT' sockets of the **PMB132** remote emergency units (up to 4). As an alternative, it is possible to connect up to 2 touch screen units **TSB8500-V**. The length of the link between the card-cage and the last station must not exceed 1000 metres at most.

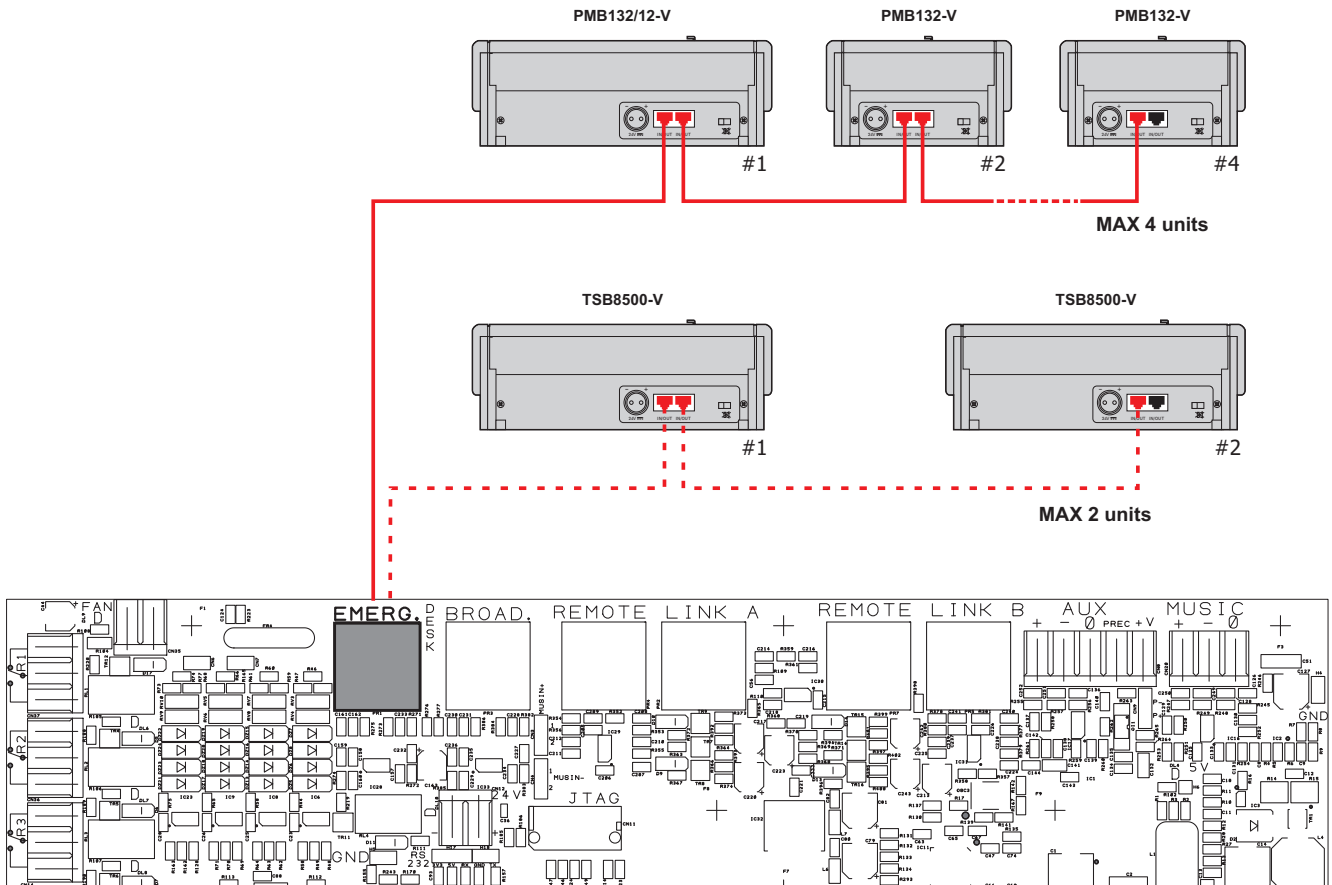

4.2.2 CONNECTION OF PAGING UNITS [CPU CIRCUIT]

Use a CAT. 5e SF/UTP cable for connecting the **BROAD.** socket (12) to the 'IN/OUT' sockets of the **PMB106/112** paging units. The length of the link between the card-cage and the last station must not exceed 1000 metres at most.

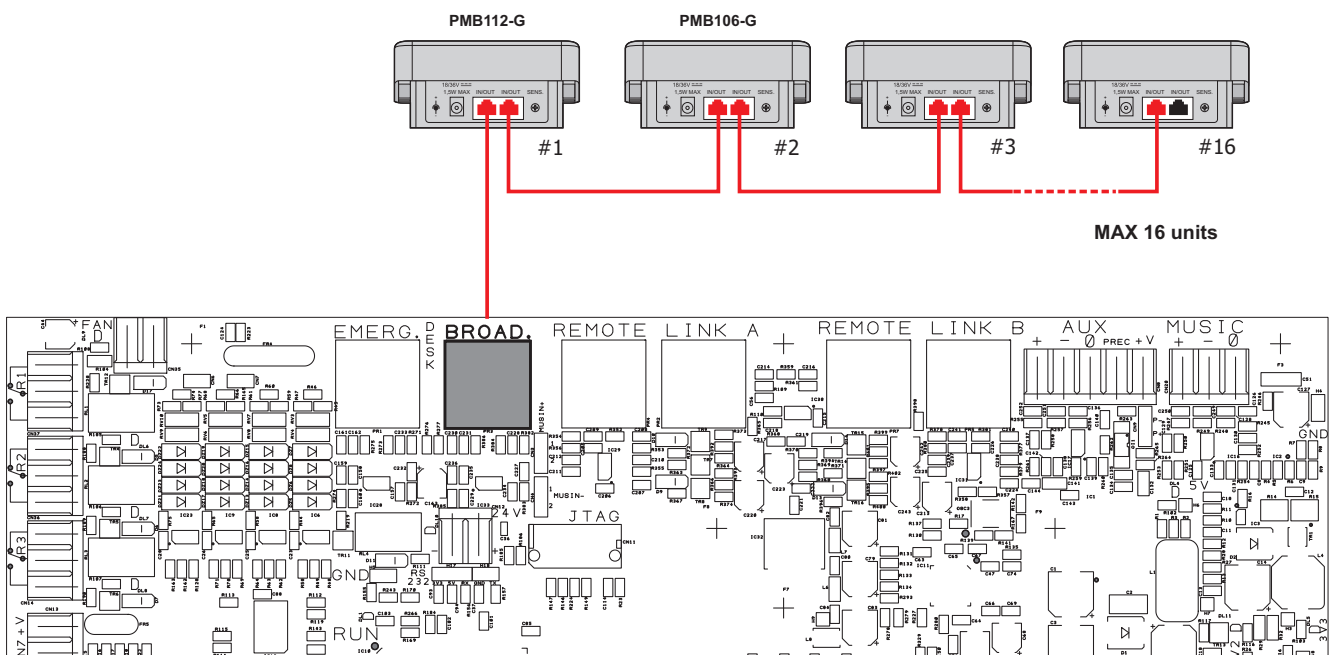

4.2.3 CONNECTION TO OTHER PAW5500-VES UNITS [CPU CIRCUIT]

Use CAT. 5e SF/UTP cables for connecting other **PAW5500-VES** units (up to a maximum total of 6 per system) via the **REMOTE LINK A/B** sockets (13). The length of the link between the first card-cage and the last unit must not exceed 1000 metres at most.

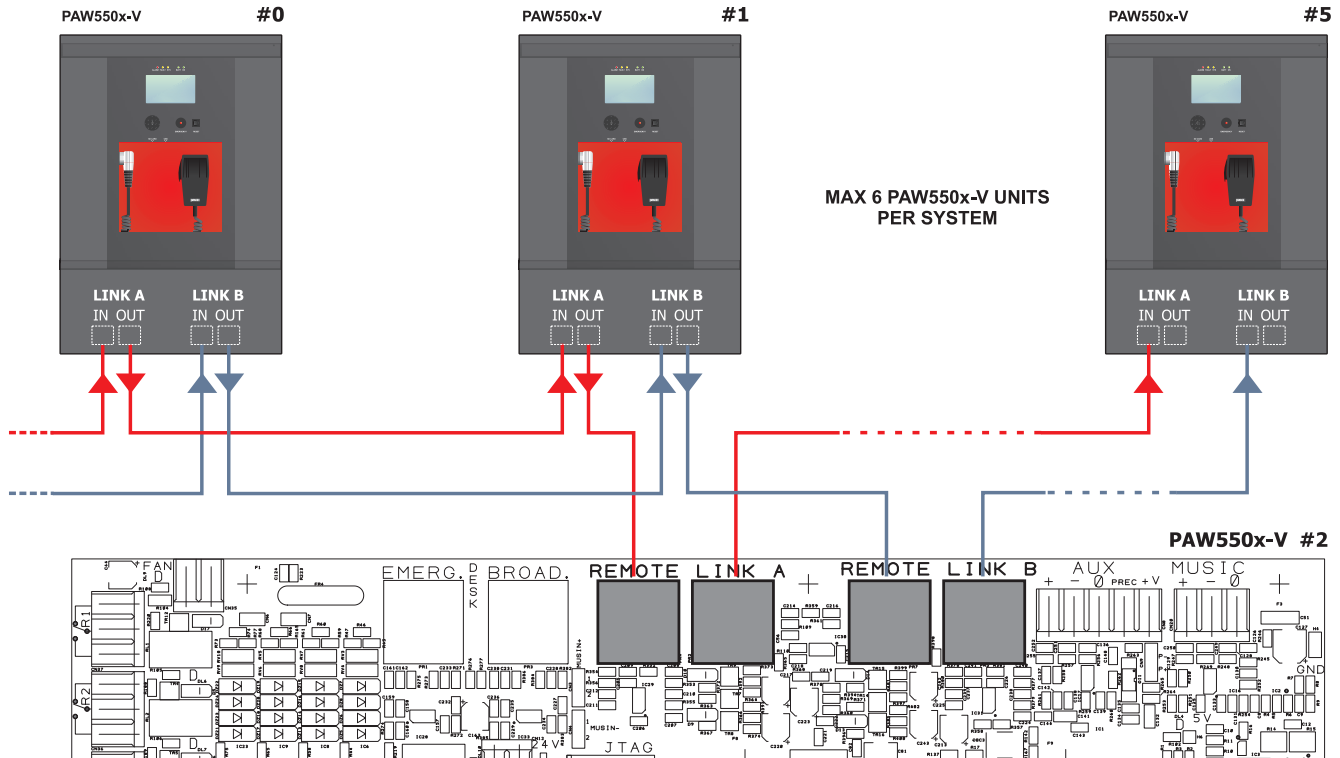

4.2.4 CONNECTION OF AUXILIARY INPUT [CPU CIRCUIT]

The **AUX** terminals (14) are available for connecting auxiliary sources (e.g. a PABX or a base for announcements with a precedence contact). In the first case, to which Fig. 1 refers, it is necessary to fit a jumper onto connector CN9 in position “P-”. In the second case, on the other hand, using a pre-amplified station of the B711-G range, connection between the AUDIO OUT socket of the base and the AUX terminals has to be made as indicated in Table 1 and the jumper will have to be positioned on “P+”. NOTE: Selection between modes P- and P+ must be made also via the menu (**AUDIO SETTING > set>AUX, CHIME**, page 27).

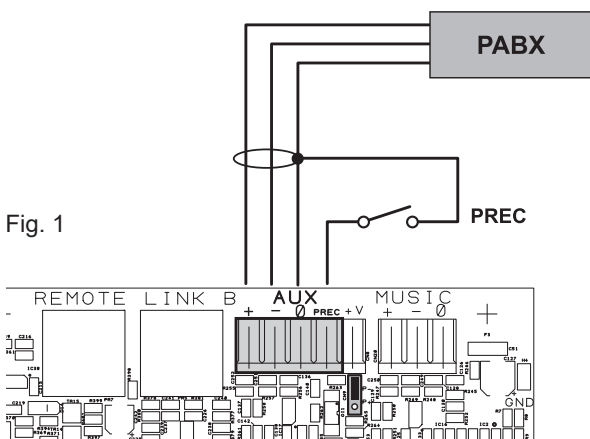

Pin	Base AUDIO OUT	PAW AUX
1	Audio +	+
2	Audio -	-
3	GND	0
4	Precedence OUT	PREC
5	Not connected	
6	+VDC	+V
7	Serial +	
8	Serial -	
Shield	GND	0

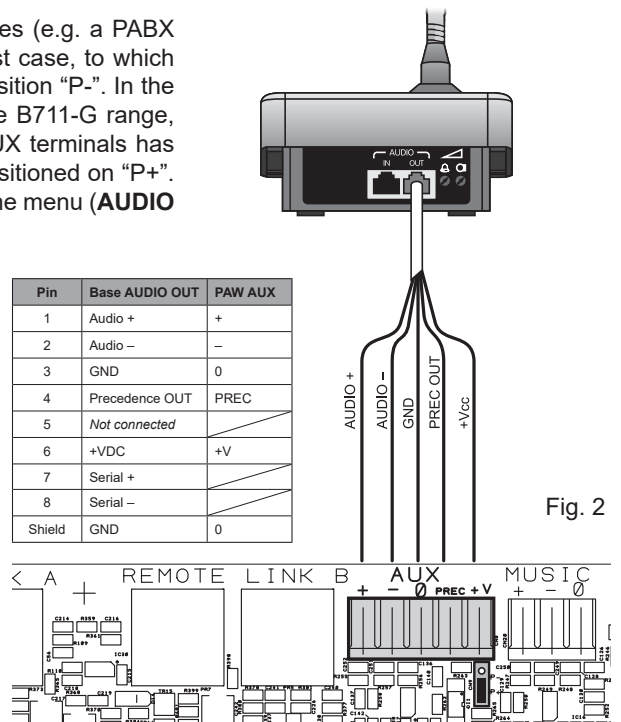

For details concerning connection and the colours of the wires, refer to the manual of the B711-G base range (Paso # 11/636-B).

#### 4.2.5 CONNECTION OF MUSIC INPUT [CPU CIRCUIT]

The **MUSIC** terminals (15) are available for connecting outside music sources (CD player, tuner etc.).

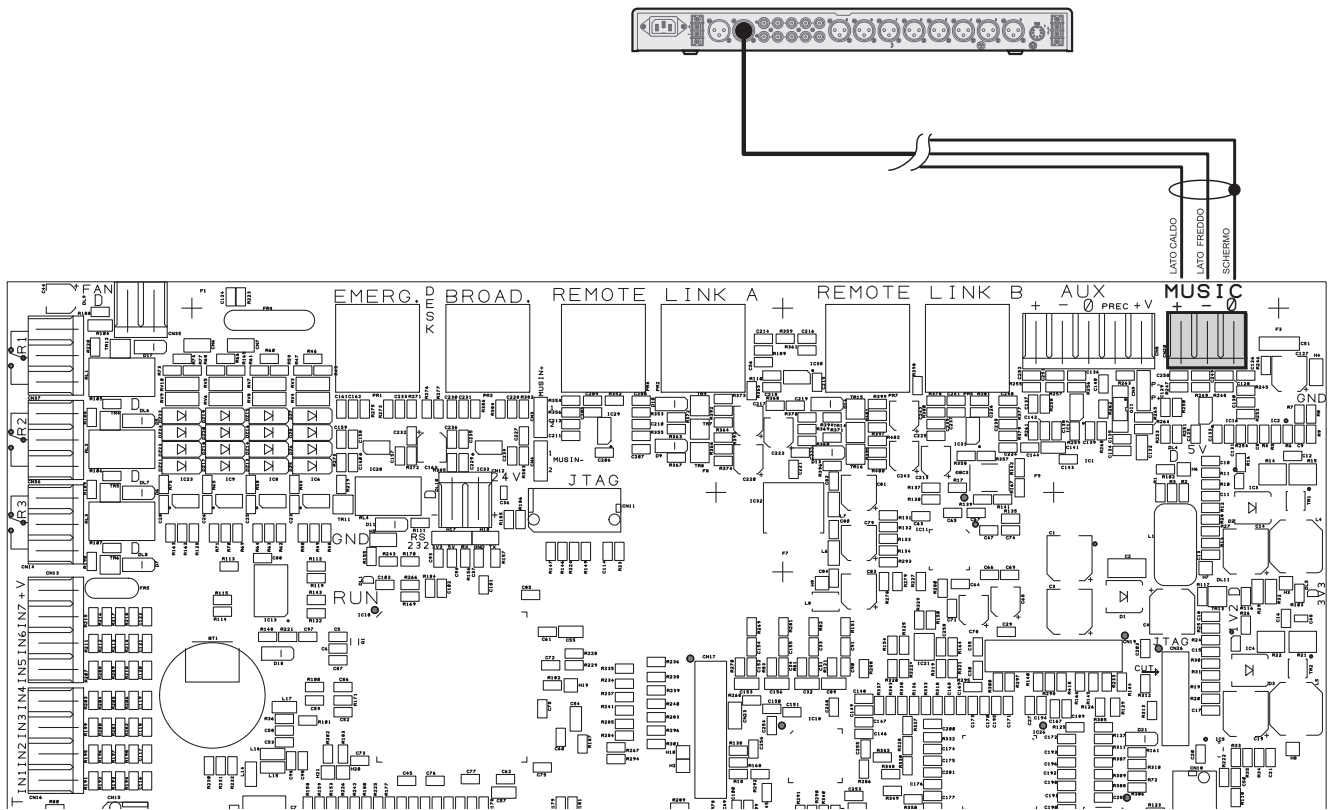

#### 4.2.6 CONNECTION OF INPUT CONTACTS [CPU CIRCUIT]

There are 7 input contacts on the **CONTACT** terminal strip (9): the figure shows an example of a connection in which contacts 1, 2, 3, 5 and 6 are of the monitored type while contacts 4 and 7 are not.

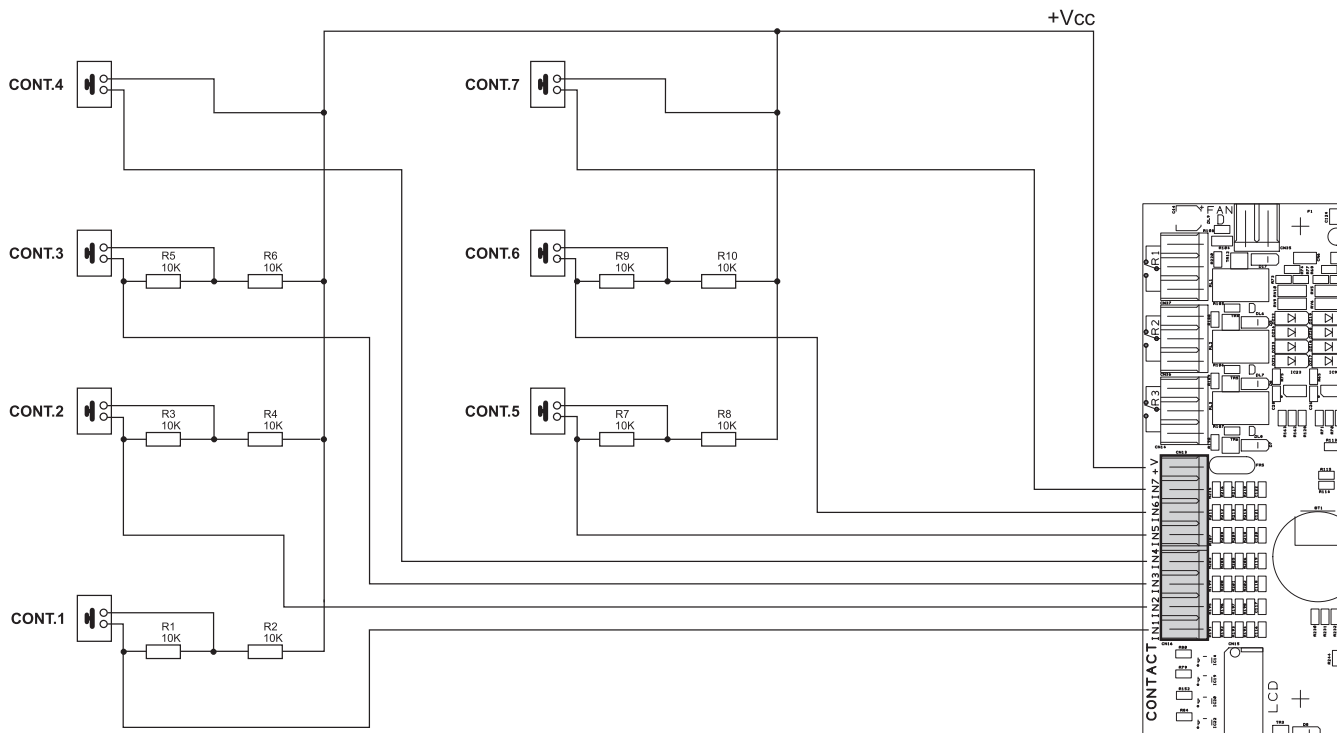

4.2.7 CONNECTION OF RELAY OUTPUTS [CPU CIRCUIT]

Three relay outputs are available on terminals **R1**, **R2** and **R3** (10) for signalling towards outside peripheral units.

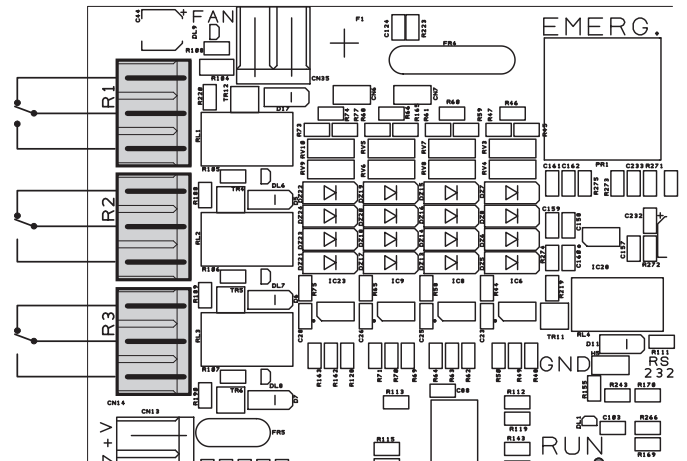

4.2.8 21 TO 29 V CONNECTION [CPU CIRCUIT]

Depending on how the PAW will be working, it is possible to receive a 21 to 24V power supply on the **24V** terminals (20), with a maximum absorption of 50 mA.

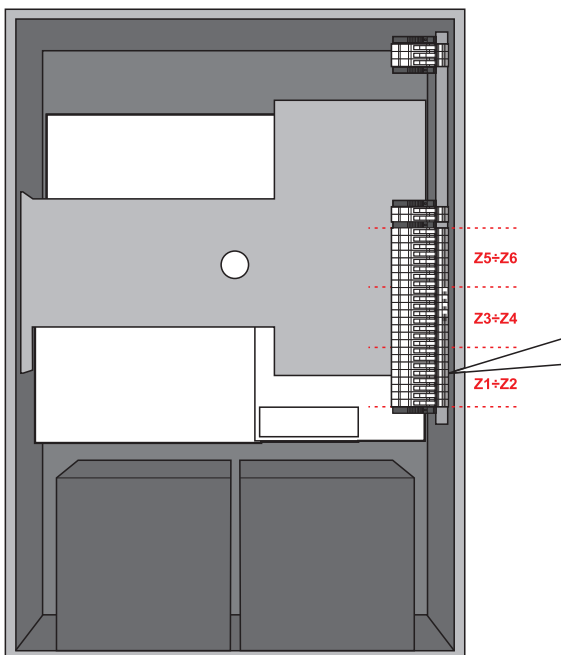
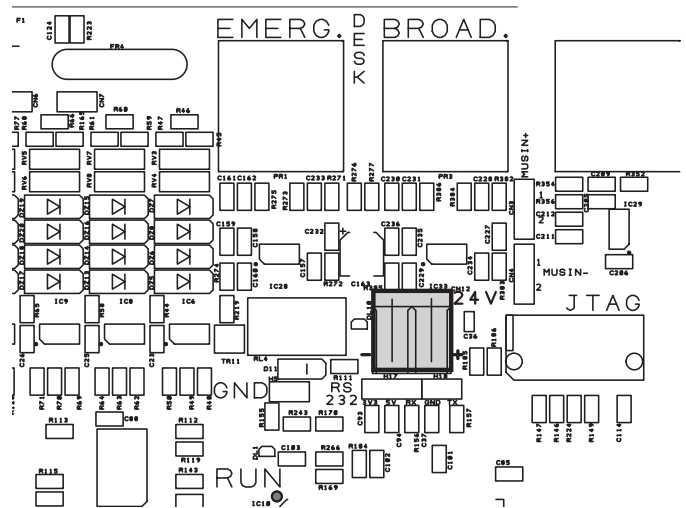

4.2.9 CONNECTION OF LOUDSPEAKER LINES

[AMPLIFIERS CIRCUIT / TERMINAL STRIP]

Terminals **A/B** (19) are dedicated terminals for connection of the loudspeaker lines. The wiring of a **PAW5502-V** model (2 zones) is shown in the figure below.

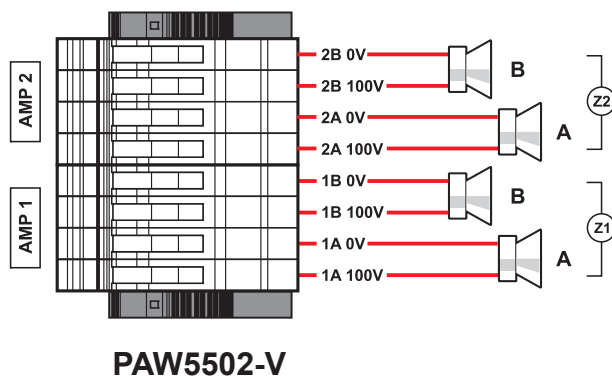

The connections for 4 and 6 zone models (respectively PAW5504-V and PAW5506-V) are shown in this figure.

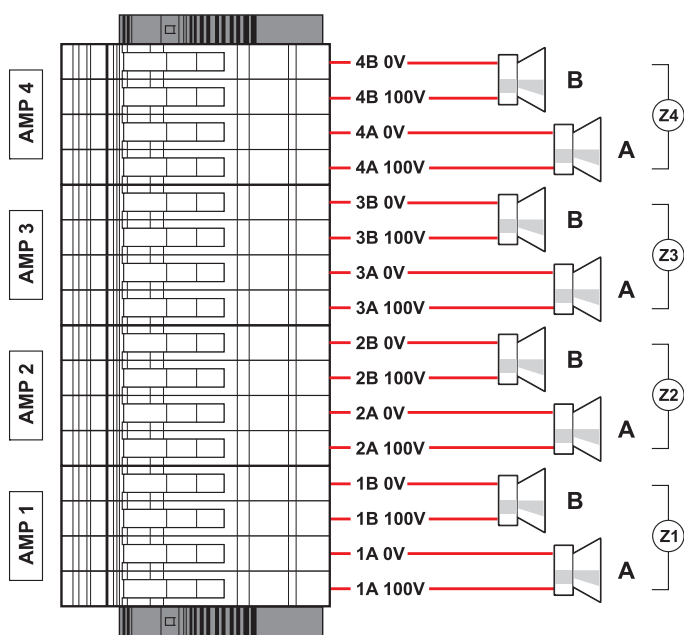

PAW5504-V

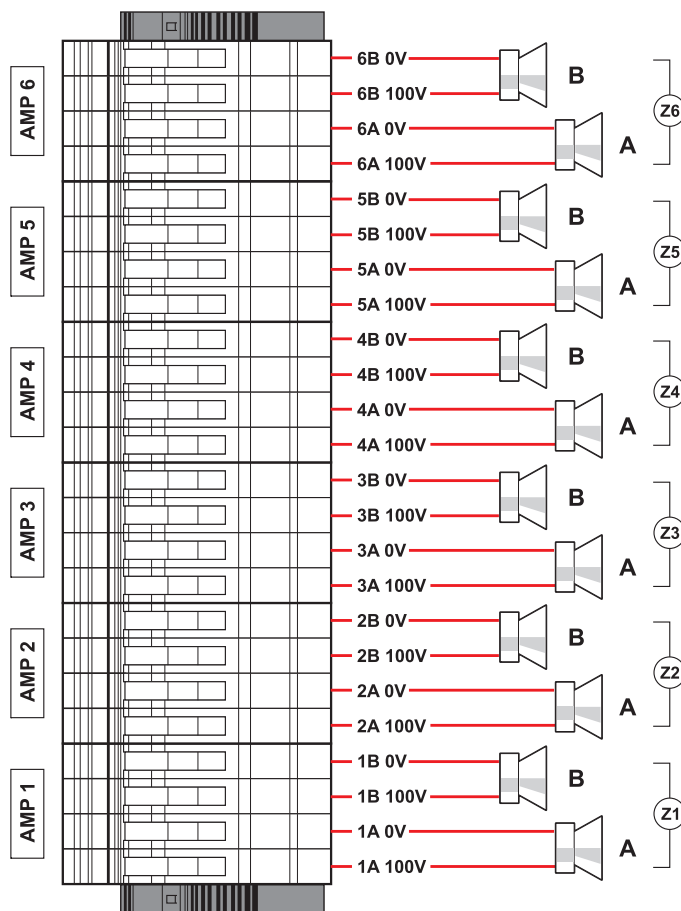

PAW5506-V

4.2.10 CONNECTION OF THE STANDBY AMPLIFIER [TERMINAL STRIP]

Using both terminal strip **R** (18) and **A/B** (19) it is possible to set a standby amplifier: here's the connection of a PAW5502-V model (1 zone + standby amplifier). In the following pages, the connections for PAW5504-V model (3 zones + standby amp) and PAW5506-V (5 zones + standby amp).

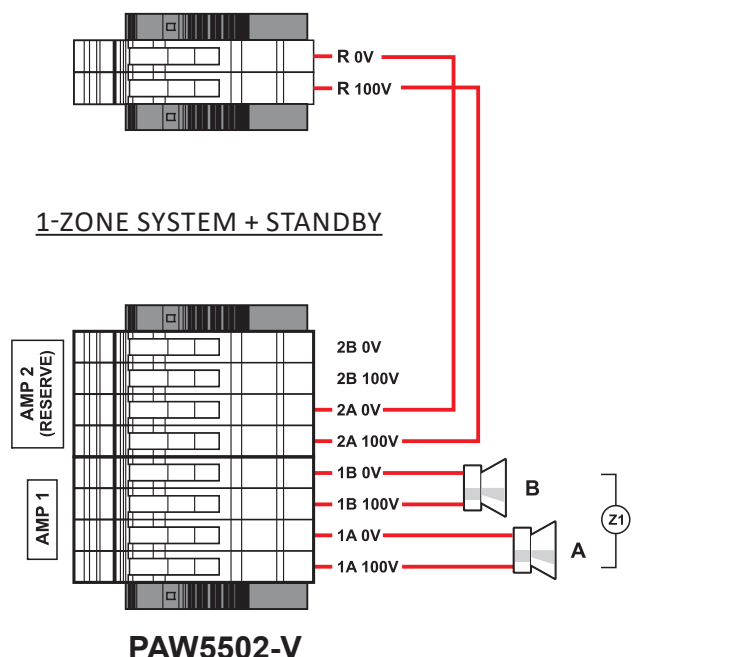
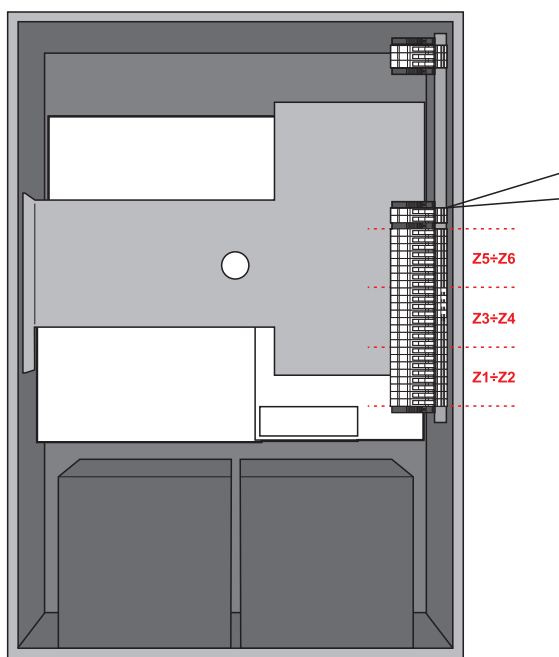

3-ZONE SYSTEM + STANDBY

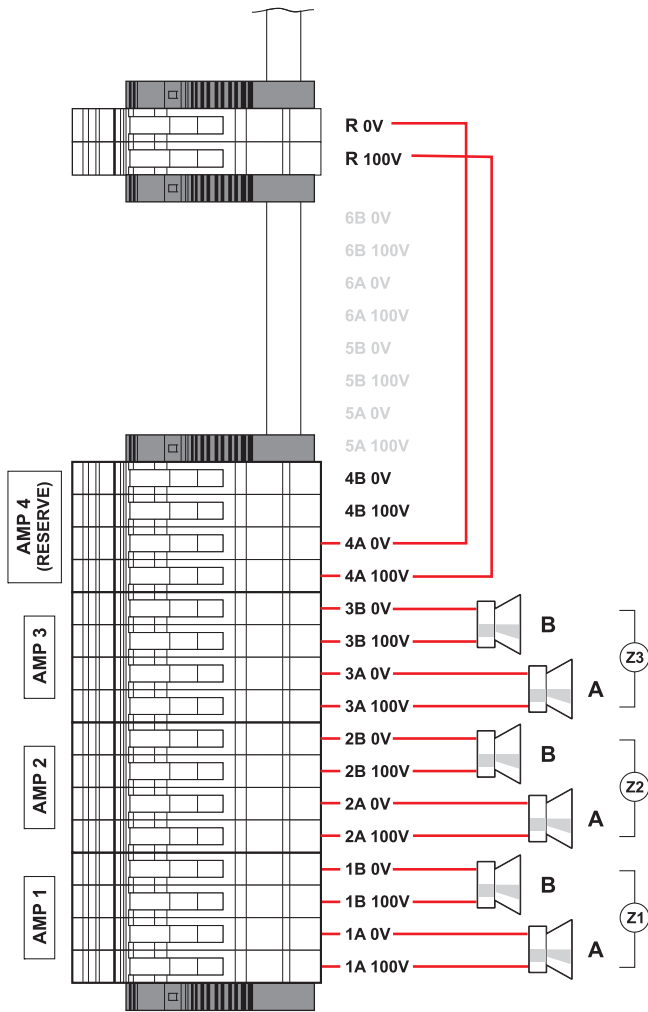

PAW5504-V

5-ZONE SYSTEM + STANDBY

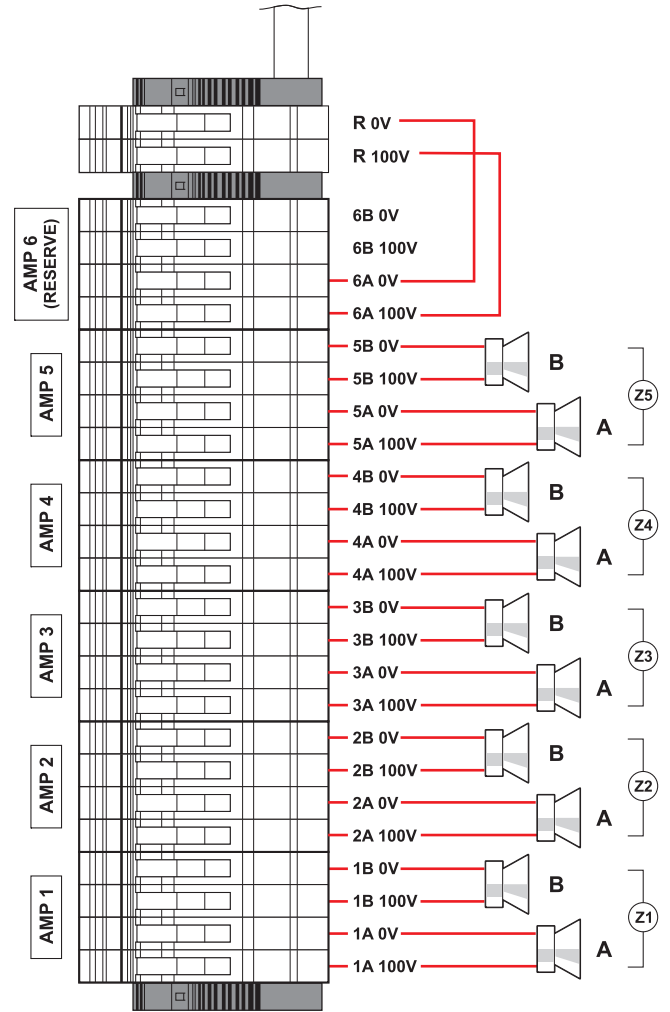

PAW5506-V



4.2.11 CONNECTION OF POWER SUPPLIES [TERMINAL STRIP AND CHARGER]

**!N.B.**  
Check that the main thermal-magnetic circuit breaker is switched OFF. If it is not, switch it OFF before carrying out any other activities in the cabinet as there is a danger of electric shocks.

**!N.B.**  
These devices have been designed to be connected to an earthed power supply. Make sure that the equipment is always connected to earth in accordance with legal regulations.

It is essential to follow the correct sequence for powering up the equipment, failing which it could be damaged.

- 1> Check that the main thermal-magnetic circuit breaker is switched OFF.
- 2> Connect the power cable coming from the thermal-magnetic circuit breaker and the earth cable to the contacts on the terminal strip (A) - see figure.
- 3> Connect the external terminals (B) of the batteries, observing the correct polarities.
- 4> Switch the thermal-magnetic circuit breaker ON.

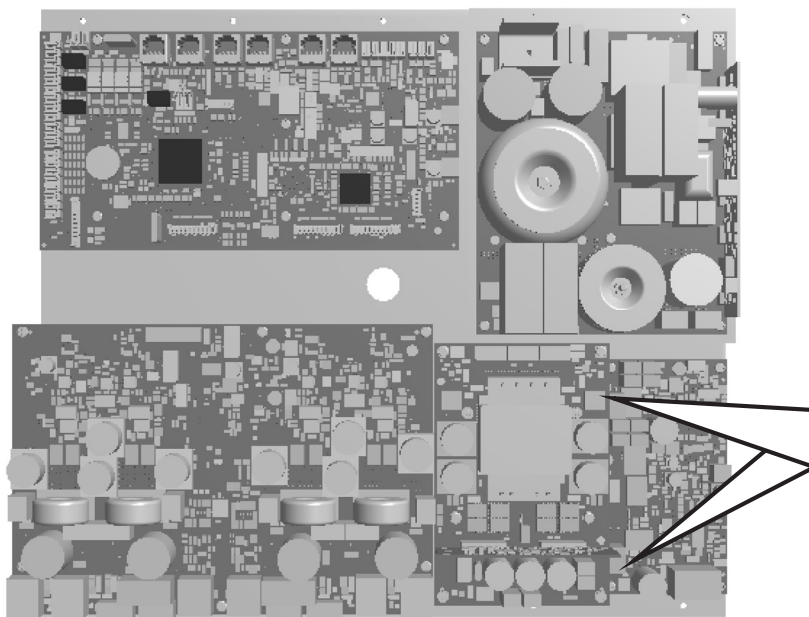
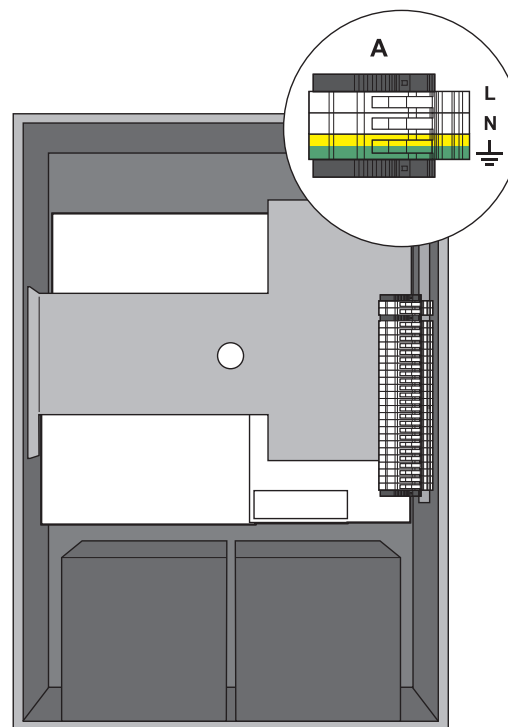

- 5> Make a jumper between the inside terminals of the batteries using the cable (C) included in the supply.
- 6> Close the front door, tightening the screws firmly.

**From now on the PAW is working.**

**NOTE:**  
If the front door is opened, the amplifiers are deactivated automatically, and can be re-activated by specialised personnel only by using a specific menu item.

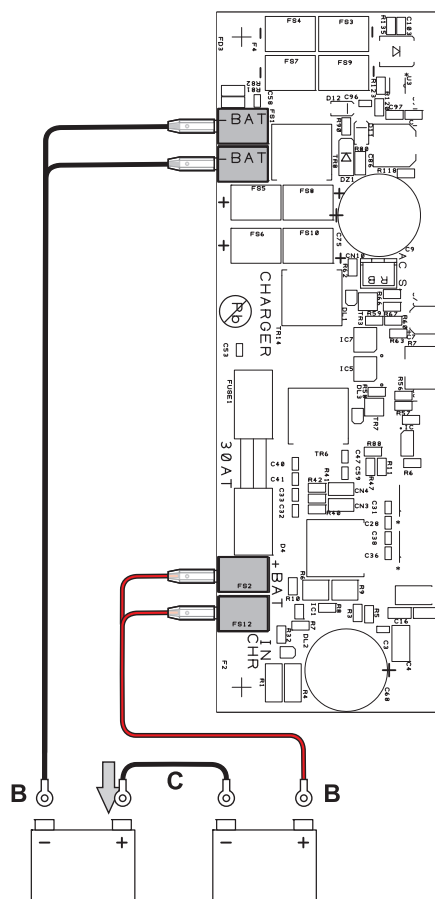

## 5. OPERATIONAL CONDITIONS AND TERMINOLOGY

Following is a list of how the operating conditions of the system are signalled and of the definitions used on the subsequent pages of the manual, completed by indications of a general nature.

### 5.1 SIGNALLING OF OPERATING CONDITIONS

The PAW is designed to signal the different operating conditions as defined below:

**Idle state** (*ALARM, FAULT and SYS LEDs off*)

Normal operating condition, with no current faults or emergencies.

**Alarm Status** (*ALARM LED on*)

Operating condition signalling the presence of at least one alarm signal, either pre-recorded or live, in at least one output zone.

**Faulty status** (*FAULT LED on*)

Operating condition signalling the presence of at least one fault detected by the internal diagnostic system, with the relevant LED turning on.

**System failure** (*SYS LED on*)

Operating condition signalling that the system has crashed due to temporary or permanent CPU malfunctioning, detected by the watchdog device.

**Automatic Emergency** (*Display showing 'AUTOMATIC EMERGENCY' with active zones*)

Sequence of operations recalled by an external peripheral unit connected to the control inputs that, depending on how these are programmed, activates the Alarm Status or resets the alarms.

**Manual Emergency** (*LED of the EMERGENCY button steady ON or flashing*)

Procedure of action on the system manual controls by an authorised operator, in order to activate emergency sources. Operations in the Manual Emergency mode have priority over those activated in the Automatic Emergency mode.

## 6. DEFINITIONS

**BGM source** (*Background Music*)

One of the audio sources that can occupy the "Music" amplification channel.

**PA source** (*Public Address*)

One of the audio sources that can occupy the "Voice" amplification channel for service announcements.

**Emergency Source**

One of the audio sources that can occupy the "Voice" and/or "Music" channels for voice emergency announcements (pre-recorded messages announcing an Alert and/or Evacuation, live messages from the local microphone, a call from a remote emergency microphone station). Activation of an Emergency Source generates the operational condition of "State of Alarm".

**Priority**

Occupation of the output zones by an audio signal or a reset order is governed hierarchically by the priority level assigned to each active source. The current activation of the area can be stopped only by another with a higher priority.

## 7. MENU STRUCTURE

The **PAW** allows system functions to be accessed through a series of Management Panels grouped, according to their operational typology and intended use, in Option Menus accessible from the MAIN MENU window. Furthermore, the following Option Menus have been assigned to different levels of access, with reference to the various circumstances requiring different degrees of skill and authorisation of the personnel assigned. In each menu it is possible to browse through the options listed by running a finger over the sidebar or pressing the 'Up' and 'Dn' (Down) buttons. To select an item, press the appropriate button. Similarly, the levels can be adjusted simply by moving the cursor along the indicator bar.

### <MUSIC> MENU | BASE LEVEL

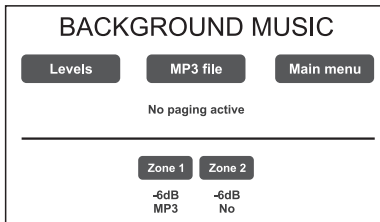

Default window for using the system in normal Idle State conditions, enabling controlling of the BGM (Background Music) sources, the selection of MP3 files from external devices (an SD card or a USB key) and adjustment of the volumes of the music section. At this basic level, the RESET button is not operational. This panel is shown immediately when the system is switched ON. To access the Main Menu press the **'Main Menu'** button. For the specific features of the MUSIC menu, see page 25.

### <MAIN> MENU | BASE LEVEL

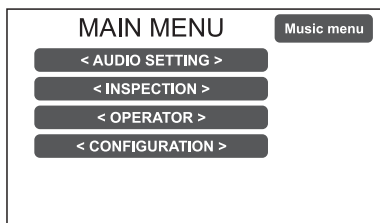

Main menu for selecting the four **PAW** operational levels. At this basic level the RESET button is not operational. To go back to the MUSIC Menu press the **'Music Menu'** button. To select the required item press the relevant key.

### <AUDIO SETTING> MENU | BASE LEVEL

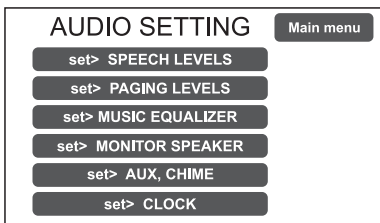

From the MAIN MENU screen, press the **< AUDIO SETTING >** key to access this menu. To select the required item press the relevant key. To return to the main screen press 'Escape'. For the specific features of the **AUDIO SETTING** menu, see page 26.

### <INSPECTION> MENU | 1<sup>ST</sup> SYSTEM LEVEL

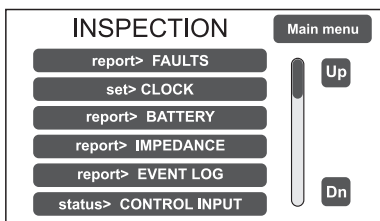

**First level of access**, for inspecting the state of the system. This is intended for the personnel responsible for initial checking of the causes of a fault or emergency. At this level the function of the RESET button is that of muting the acoustic signal indicating the FAULT. To select the required item press the relevant key. To go back to the main menu Press 'Main menu'. For the specific features of the menu **INSPECTION**, see page 29.

### <OPERATOR> MENU | 2<sup>ND</sup> SYSTEM LEVEL

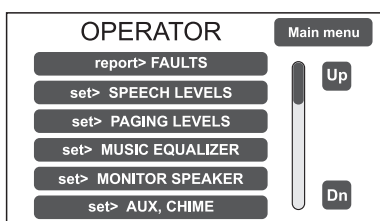

**Second level of access**, for instructed personnel authorised to manage the system in emergency, failure and disabled conditions. The relevant login password must be entered to access this menu. To go back to the main screen press 'Main menu'. For the specific features of the **OPERATOR** menu, see page 32.

### <CONFIGURATION> MENU | 3<sup>RD</sup> SYSTEM LEVEL

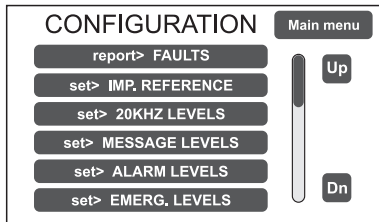

**Third level of access**, for instructed personnel authorised to work on the advanced functions of the system and to alter the configuration parameters, for starting up and altering the system. The relevant login password must be entered to access this menu. To go back to the main screen press 'Main menu'. For the specific features of the **CONFIGURATION** menu, see page 35.

### <SERVICE> MENU | 4<sup>TH</sup> SYSTEM LEVEL

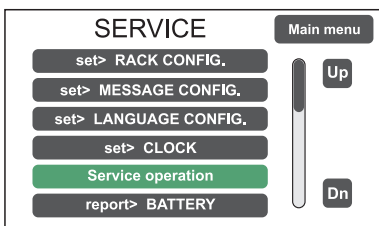

**Fourth level of access**, included among the options of the CONFIGURATION menu, for technical assistance, firmware up-dating and altering the **PAW** system operating parameters. Use is permitted only to personnel of the technical service who have the necessary login password. To go back to the main screen press 'Main menu'.

### <EMERGENCY> MENU | ACTIVE

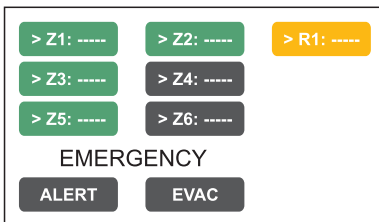

**Operational environment for managing Manual Emergencies with top priority.** Accessible at all times with the dedicated "EMERGENCY" key, it can be used by authorised personnel only, suitably instructed with regard to the Emergency and Evacuation Plan (PEE). For the specific features of the EMERGENCY menu, see page 44.

### <EMERGENCY> MENU | PASSIVE

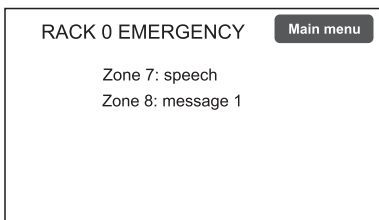

**This window appears automatically** and shows the card-cage emergency status called up from emergency microphone stations, control inputs or other card-cages. It is possible to access the other menus (except for the music menu) by pressing 'Main menu'.

## 8. USING THE SYSTEM

After making all the connections and supplying power to the card-cage, observing the indications provided in the relevant chapter, and once the door of the cabinet has been closed, the display lights up and shows the panel of the MUSIC Menu, from which it is possible, by pressing the **'Main Menu'** key, to access the main screen for selecting the menus.

If the system is being used for the first time, or if changes have been made to its configuration, proceed as indicated in the CONFIGURATION OF THE SYSTEM section. If, on the other hand, the initialisation procedure has already been completed, continue with the indications for use as provided below.

- **For normal use** for broadcasting music and microphone announcements, users may limit their activities to the **MUSIC** and **AUDIO SETTING** menus.
- For management in faulty/emergency conditions and for configuration using advanced functions, see the **INSPECTION**, **OPERATOR** and **CONFIGURATION** menus.
- For sending emergency messages, see the **MANUAL EMERGENCY** section.

### 8.1 CONFIGURATION OF THE SYSTEM

Configuration activities may be carried out only by qualified personnel, suitably trained for this purpose.

#### A) Password

From the MUSIC MENU, go to the MAIN MENU and select < CONFIGURATION >. If access only with a password is enabled, 'Enter configuration password' will appear on the screen.

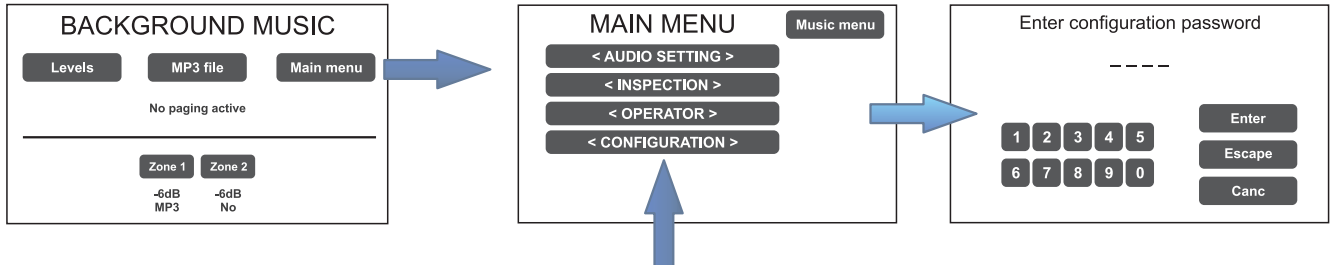

Enter the 4-digit code of the password and confirm by pressing 'Enter' (the factory default password is 3333; see page 35).

#### B) Muting the BEEP

During the initialisation process, it is possible that faults may be detected due to differences between the configuration of the system being connected and the values set by default. To mute the acoustic signal (beep) temporarily, browse down through the CONFIGURATION menu and select the item 'Beep operation'.

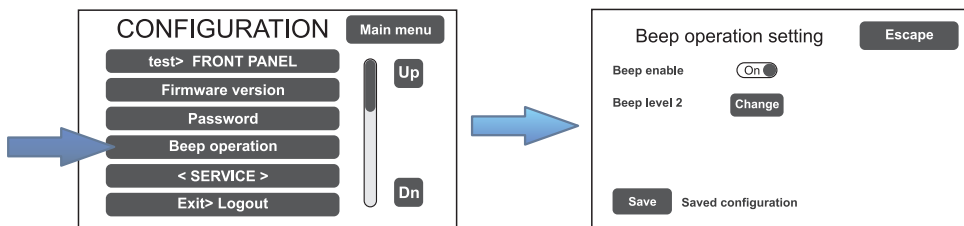

In the 'Beep operation setting' window, move the 'Beep enable' slider to 'Off'. Press 'Save' to save this setting.

#### ! N.B.

In order to comply with regulations, before returning the equipment to its normal operation it is necessary to enable the acoustic signalling by returning the 'Beep enable' slider to its 'On' position.

#### C) Acquisition of impedances

From the CONFIGURATION menu, select the item 'set> IMP. REFERENCE' to access the 'Zone reference setting' screen page.

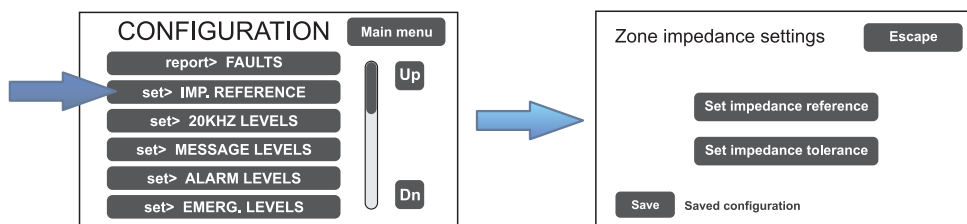

From here it is possible to set the reference impedance and the tolerance for controlling the impedance of the loudspeaker lines (refer to the point on Acquisition of impedance and setting of tolerance on page 36).

**D) Rack configuration**

In the CONFIGURATION menu, browse through the items and select '**set>RACK CONFIG**'. From here it is possible to configure all the basic settings of the system.

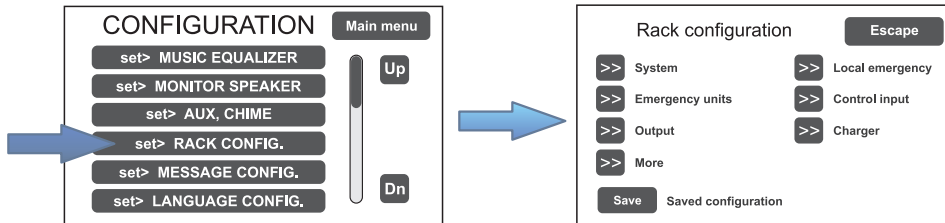

**D1) >> System**

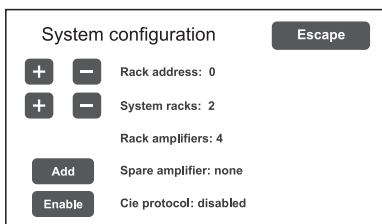

On the '**System configuration**' screen page, use the [ + ] and [ - ] keys to set the following:

**Rack address:** ID address of the **PAW** (from 0 to 5).

**System racks:** number of **PAWs** present in the system (6 at most).

**Spare amplifiers:** standby amplifier (add or remove).

The item 'Rack amplifiers' automatically shows the number of amplifiers present in the system.

**D2) >> Emergency units**

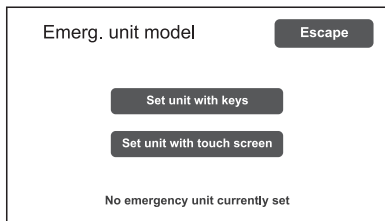

On the '**Emerg. unit model**' screen page, use the sub-menus to set the configuration of the emergency units.

**Set unit with keys** Configuration of the keys of the stations

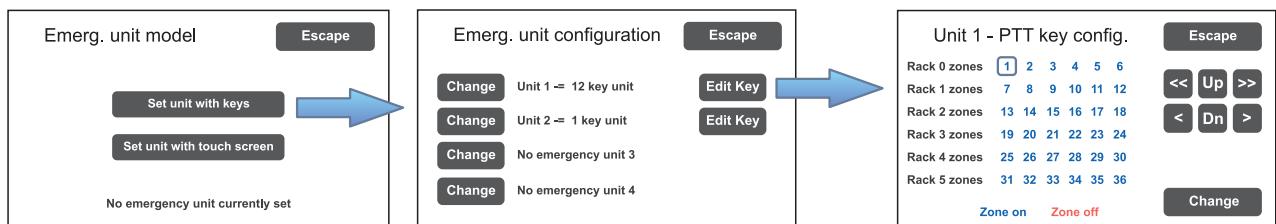

In an emergency system with **PAW5500-VES** control units, it is possible to connect up to four remote emergency units: click on '**Change**' to set the unit type:

1 key unit = single zone unit (**PMB132-V**)

12 key unit = 12-zone unit (**PMB132/12-V**)

Then press '**Edit Key**' to configure each key (see *Emergency units* on page 38).

By pressing '**Set unit with touch screen**', the screen page on which it is possible to confirm the presence or otherwise of **TSB8500-V** stations connected to the PAW will appear.

**D3) >> Local emergency**

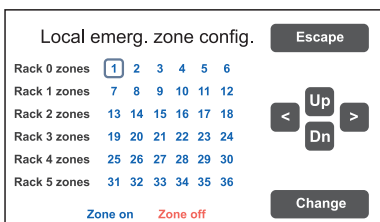

Screen page for setting the zones in which the emergency messages will be broadcast. The panel shows the situations of all the PAWs present in the system. Move in the table using the arrows and the Up and Dn keys. The zones selected in this window are called up directly on pressing the EVAC / ALERT / PTT keys if no selections are made in the emergency menu.

**Blue = Active zone / Red = Inactive zone**

**D4) >> Control input**

Screen page for managing the inputs being controlled (1 to 7). Use the 'Next' and 'Prev.' Keys to move from one input to another.

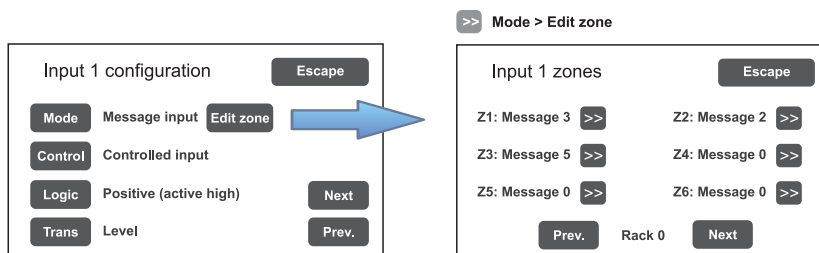

- Mode** Setting of the operating mode of the input (message, reset or de-activated) and of the relevant zones (only if the item "Message input" is selected).
- Control** Enabling/disabling of control of the selected input.
- Logic** Setting of the logic for input activation.
- Trans** Enabling of the level or transition input.

**D5) >> Output**

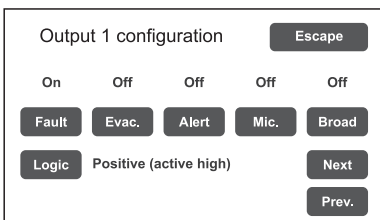

Screen page for setting the outputs (1 to 3).

Use the 'Next' and 'Prev.' keys to move from one output to another.

**D6) >> Charger**

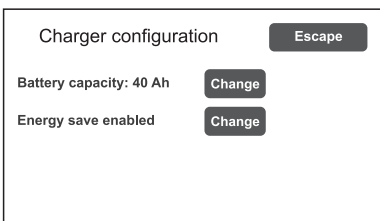

On selecting the item >>Charger this screen page containing information about the internal batteries appears.

**Battery capacity**

Press 'Change' to select a value: 18, 26, 33 or 40 Ah. Please see page 40 for details.

**Energy save (enabled/disabled)**

For enabling/disabling the function allowing the batteries to go into the energy saving mode in the absence of the mains power supply.

**!** N.B. In order to comply with the regulations, the "Energy save" function should always be enabled.

### D7) >> More

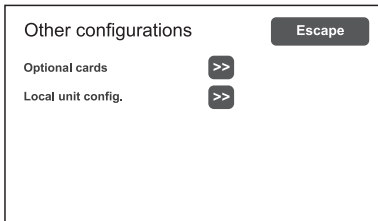

On selecting the item >>More, this screen page appears, enabling the selection of:

- Broadcasting stations to be set as local. On activating this function, keys 1 to 6 of the station will correspond, in the same order, to the zones of the card-cage to which the station itself is connected (e.g. if the local base is connected to card-cage 2, key 1 will correspond to zone 13, key 2 to zone 14 and so on). It is advisable to use Paso **PMB106-G** units as local stations.
- Selection of an optional card, if any, present in the system (**ACPAW-2IN** or **ACPAW-6IN**).

### E) Emergency messages

The default messages (alert, evacuation and warning signal) are stored in the PAW5500-VES's internal flash memory. It is also possible to download customised .wav files from an external device (an SD card or USB key). To access the appropriate screen, from the CONFIGURATION menu select item: **set> MESSAGE CONFIG.** See page 41 for the relevant operations.

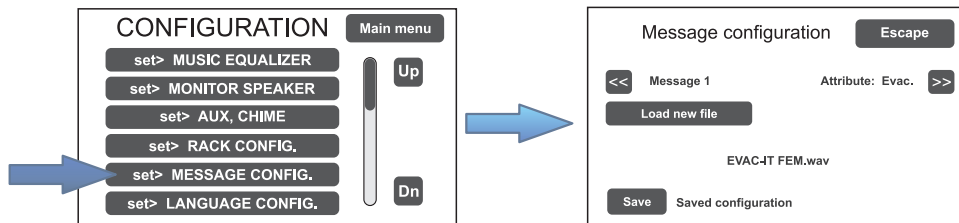

### F) Language selection

The default factory-set language of the equipment is English. The new PAW5500-VES range enables other languages, pre-installed and stored in the internal flash memory, to be selected. To access the appropriate screen, from the CONFIGURATION menu select item: **set> LANGUAGE CONFIG.** See page 41 for the relevant operations.

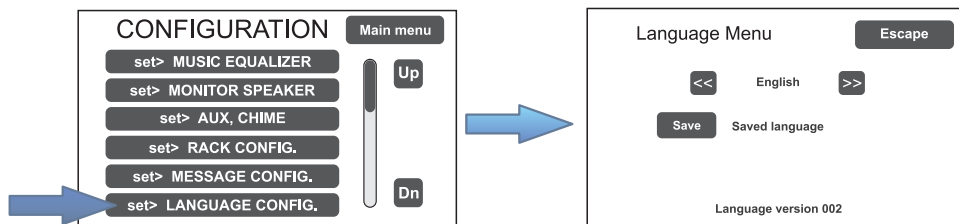



8.2 MUSIC MENU

SETTING THE AUDIO PARAMETERS OF BGM SOURCES

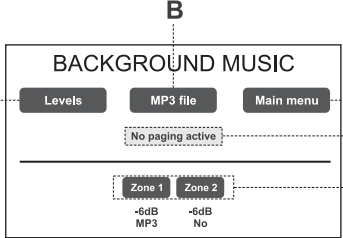
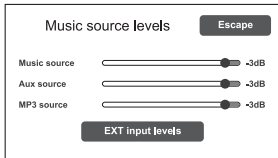
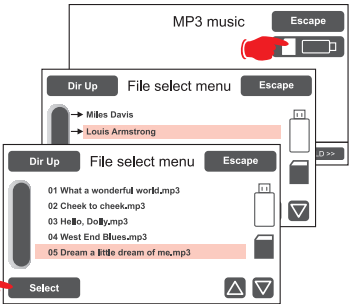
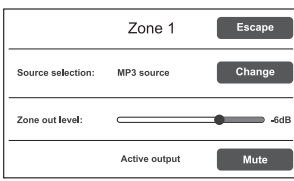
Screen page	Description of main panel	Description of options
 <p>The screenshot shows the 'BACKGROUND MUSIC' menu. At the top, there are three buttons: 'Levels' (callout A), 'MP3 file' (callout B), and 'Main menu' (callout C). Below these is a status indicator 'No paging active' (callout D). At the bottom, there are two zone selection buttons: 'Zone 1' and 'Zone 2' (callout E). Under 'Zone 1', it shows '-6dB MP3'. Under 'Zone 2', it shows '-6dB No'.</p>	<p>Music source control panel displayed by the PAW in conditions of normal "Idle" state:</p> <p><b>Navigation keys:</b></p> <p><b>Levels (A): Music source levels</b> Access to the panel for adjusting the input levels of the available BGM sources.</p>  <p>The 'Music source levels' panel features three sliders for 'Music source', 'Aux source', and 'MP3 source', each with a '-3dB' indicator. An 'EXT input levels' button is located at the bottom.</p> <p><b>MP3 file (B): MP3 music</b> Access to the panel for selecting MP3 music files from external media (SD cards or USB devices).</p>  <p>The 'MP3 music' menu shows a 'File select menu' with a list of files: '01 What a wonderful world.mp3', '02 Cheek to cheek.mp3', '03 Hello, Dolly.mp3', '04 West End Blues.mp3', and '05 Dream a little dream of me.mp3'. A 'Select' button is at the bottom.</p> <p><b>Main menu (C)</b> Access to the main menu screen.</p> <p><b>No paging active / Paging active (D)</b> Indication of the presence of broadcasting calls.</p> <p><b>Zone 1 to 6 (E) &gt; Zone X</b> Access to the panel for selecting music sources and adjusting the output level. Press Change to select the required source and move the cursor along the 'Zone out level' bar to set the music output volume. Press 'Mute' to mute the music without changing its output level. Press it again to reactivate the music.</p>  <p>The 'Zone 1' panel shows 'Source selection: MP3 source' with a 'Change' button, a 'Zone out level' slider with a '-6dB' indicator, and an 'Active output' button with a 'Mute' option.</p>	<p>Thanks to the different panels, the new PAW5500-VES range systems enable independent selection of the various music sources.</p> <p>By pressing the relevant zone key, one of the following music sources can be selected:</p> <ul style="list-style-type: none"> <li>- No music</li> <li>- Music source (MUSIC IN)</li> <li>- Aux source (AUX IN)</li> <li>- MP3 source (SD e/o USB)</li> <li>- EXT1 + EXT6 source (ACPAW-2IN, ACPAW-6IN).</li> </ul> <p>In each zone panel, slide the cursor along the bar to adjust the relevant output volume and to set the required level of attenuation (from 0 dB to -70 dB/Off).</p> <p>This value will be stored for each BGM source and shown below the relevant button.</p> <p>The output can be activated/muted using the 'Mute' key, without changing the output level of the zone itself.</p> <p>Input volume adjustment for all the sound sources is available on a single panel (Levels &gt; Music source levels).</p> <p><b>SELECTION OF MP3 FILES</b> After pressing the 'MP3 File' key, select the device on which to look for the files by clicking on the appropriate icon (SD or USB stick). Use the 'Dir Up' and 'Dir Down' keys to search inside the folders and the arrows to scroll through the lists of files. After highlighting the required track, press SELECT: the play panel with the relevant controls will appear.</p> <p><b>ACTIVATION AND DEACTIVATION OF THE MUSIC FOR EACH OUTPUT ZONE</b> Music has been activated for a zone when the relevant key is green. If it is not activated, the key will be blue.</p> <p>To change the state of activation, press the zone key once, then press the 'Mute' key.</p>

### 8.3 <AUDIO SETTING> MENU

#### SETTING THE AUDIO PARAMETERS OF THE PA SOURCES

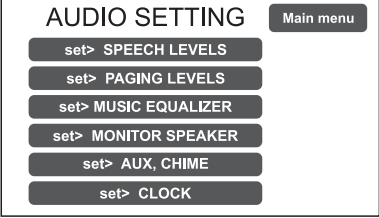
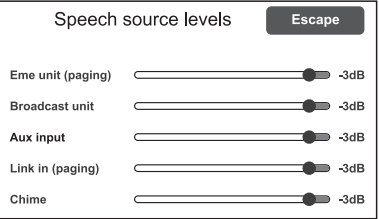
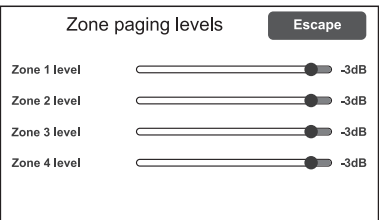
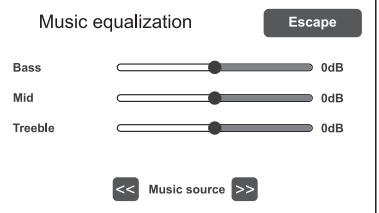
Screen page	Description of the main panel	Description of options
	<p>Music and broadcast source control panel displayed by the <b>PAW</b> in conditions of normal "Idle" state operation.</p> <p>From this panel it is also possible to set the timers for programmed playing out of the broadcast messages.</p> <p>To select the desired item, press the relevant key.</p> <p>To return to the main screen, press '<b>Main Menu</b>'.</p>	<p>The options of the AUDIO SETTING menu enable access to the following panels:</p> <p><b>set&gt; SPEECH LEVELS</b>  <b>set&gt; PAGING LEVELS</b>  <b>set&gt; MUSIC EQUALIZER</b>  <b>set&gt; MONITOR SPEAKER</b>  <b>set&gt; AUX, CHIME</b>  <b>set&gt; CLOCK</b>  <b>set&gt; TIMERS</b></p>
<p><b>set&gt; SPEECH LEVELS</b></p> 	<p><b>Adjustment of the voice sources</b></p> <p>On this screen page the volume of the voice sources connected to the <b>PAW</b> can be adjusted.</p> <p>To change the value indicated, move the cursor along the bar next to each source.</p> <p>To return to the &lt; AUDIO SETTING &gt; screen, press '<b>Escape</b>'.</p>	<p><b>Relevant items</b></p> <p><b>Eme unit (paging)</b> Remote emergency units on broadcasting calls.</p> <p><b>Broadcast unit</b> Broadcasting stations.</p> <p><b>Aux unit</b> Auxiliary input.</p> <p><b>Link in (paging)</b> Broadcasting calls coming from other linked <b>PAW</b>'s.</p> <p><b>Chime</b> Warning signal.</p>
<p><b>set&gt; PAGING LEVELS</b></p> 	<p><b>Adjustment of the output level</b></p> <p>On this screen page the output volume during broadcasting calls can be adjusted zone by zone.</p> <p>To change the indicated value, move the cursor along the bar next to each source.</p> <p>To return to the &lt; AUDIO SETTING &gt; screen, press '<b>Escape</b>'.</p>	
<p><b>set&gt; MUSIC EQUALIZER</b></p> 	<p><b>Equalisation of the music source tones</b></p> <p>On this screen page music quality can be corrected by means of a three-band equalizer.</p> <p>To change the indicated value, slide the cursor along the bar next to each band.</p> <p>To return to the &lt; AUDIO SETTING &gt; screen, press '<b>Escape</b>'.</p>	

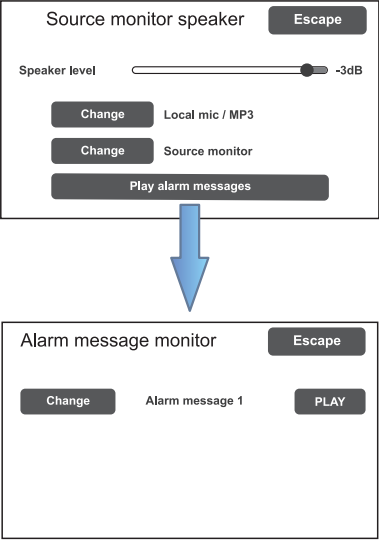
<p><b>set&gt; MONITOR SPEAKER</b></p> 	<p><b>Management of monitor speaker</b></p> <p>On this panel, in addition to adjusting the volume of the monitor speaker on the <b>PAW</b>, it is possible to enable sounding of the input and output signals of the equipment.</p> <p>The <b>Source Monitor Speaker</b> screen enables one of the input sources to be played back, while the <b>Zone Monitor Speaker</b> enables one of the output zones to be played back.</p> <p>The <b>Play Alarm Messages</b> key enables access to the screen page where it is possible to listen via the monitor speaker to the pre-recorded messages stored in the PAW's internal memory. Press 'Change' to browse through the various messages, 'PLAY' to start playing and 'STOP' to stop it.</p>	<p><b>Sources available for selection</b></p> <ul style="list-style-type: none"> <li>Local mic / MP3</li> <li>Emergency units</li> <li>Link A input</li> <li>Link B input</li> <li>Broadcast unit</li> <li>Music source</li> <li>Aux source</li> <li>Ext1 to Ext6 source</li> <li>Speaker monitor off</li> </ul> <p><b>Selectable zones</b></p> <ul style="list-style-type: none"> <li>Output on zone X</li> <li>Speaker monitor OFF</li> </ul>
---	---	---

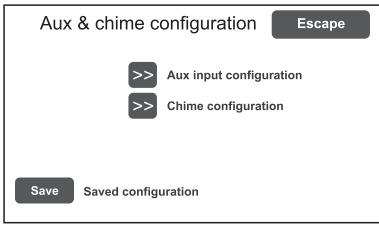
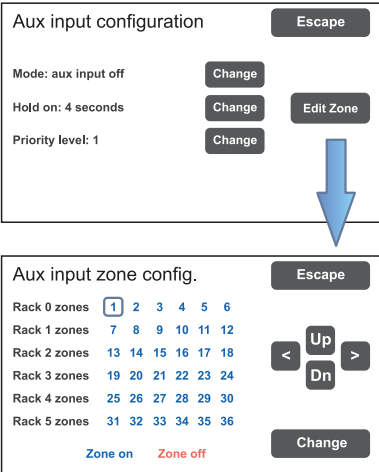
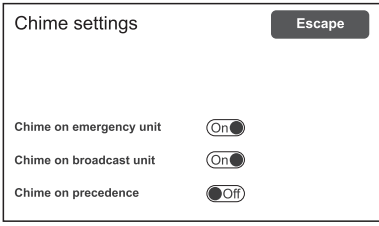
<p><b>set&gt; AUX, CHIME</b></p> 	<p><b>Management of AUX and CHIME inputs</b></p> <p>Configuration of the auxiliary input and of the chime is accessed from this panel.</p>	
<p><b>Aux input configuration</b></p> 	<p><b>Aux input configuration</b></p> <p>On this screen the configuration of the auxiliary input can be set, selecting the Mode, the hold-on time for VOX at the end of a call and the <i>Priority Level</i> of a call.</p> <p>Using the <b>Edit zone</b> button, another screen page is accessed where the call zones can be selected upon activation of the AUX input, using the <b>arrow</b> and <b>Up/Dn</b> keys.</p>	<p><b>Mode</b></p> <ul style="list-style-type: none"> <li>Aux input off</li> <li>Input VOX level 1÷7</li> <li>Aux input on</li> <li>Aux with prec. +</li> <li>Aux with prec. -</li> </ul> <p><i>Precedence modes also require appropriate setting of the P+/P- jumper on the CPU board.</i></p> <p><b>Hold on</b></p> <p>0 / 1 / 2 / 4 / 8 / 16 sec.</p> <p><b>Priority level</b></p> <p>1÷7</p>
<p><b>Chime settings</b></p> 	<p><b>Chime configuration</b></p> <p>On this screen, chimes for calls coming from emergency stations, from broadcasting stations or from the precedence contact can be enabled or disabled independently.</p> <ul style="list-style-type: none"> <li>Chime on emergency unit (on/off)</li> <li>Chime on broadcast unit (on/off)</li> <li>Chime on precedence (on/off)</li> </ul>	

## set&gt; CLOCK

## Displaying current date and time

On this screen page the system time can be displayed (it is not possible to make any changes, which are permitted at the higher access levels). Press 'Escape' to return to the < AUDIO SETTING > screen.

## set&gt; TIMERS

## Setting the timers

On this screen it is possible to set up to 16 timers that enable timed events (such as sending of broadcast messages) to be activated and/or the activation of relays.

Press 'Next' and 'Prev.' Keys to select the required timer (from 1 to 16).

Pressing the 'Change' key, to set the timer state:

- *Activated timer (timer activated)*

- *Not activated timer (timer not activated)\**

\*The second option enables temporary de-activation of a timer that has been set.

Press 'Timer' to set the timer on a weekly basis.

Use the << / < and > / >> keys to set the time and to select the days on which the event should be called up.

Press 'Zones' to select the message and the zone in which it is to be played out. If there are more than one PAWs in the system, the zones controlled by these card-cages can also be selected.

Press 'Repeat' to set the timer repetitions, expressed in minutes:

- *Interval (interval between repetitions)*

- *Range (total duration of the repetition)*

Press 'Relay' to activate one of the relays\*.

\*If available, that is to say not already programmed during configuration for other events.

To return to the < AUDIO SETTING > menu press **Escape**.

### 8.4 <INSPECTION> MENU

#### SYSTEM STATUS INSPECTION

This menu is intended for selecting options for system status inspection.

It is for use by the personnel in charge of initial checking of the causes leading to a fault or to an emergency state.

In this menu it is possible to select:

- report> FAULTS
- set> CLOCK
- report> BATTERY
- report> IMPEDANCE
- report> EVENT LOG
- status> CONTROL INPUT
- test> FRONT PANEL
- < OPERATOR >
- < CONFIGURATION >

To return to the main screen press **Main menu**.

report> FAULTS	Investigation on faulty conditions
	<p>Six items are listed with a general indication of the fault status. The categories of the faulty parts and the status general reporting are shown in the following table. Press the required item to access the chosen sub-panel and view the details of the fault as illustrated on the following screens.</p> <p>To return to the INSPECTION menu press <b>Escape</b>.</p>

Label	Category subject to diagnosis	See panel	Notes
Loudspeaker lines	Loudspeaker lines		The diagnosis status is reported for each output line.
Voice alarms	Voice emergency sources		For each monitored element, additional sub-panels can be accessed, where the diagnosis status is reported.
Amplifiers	Amplifiers		The diagnosis status is reported for each monitored element.

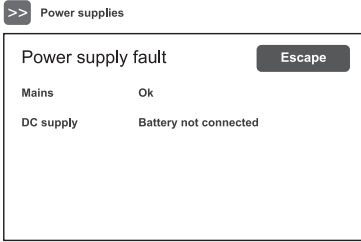
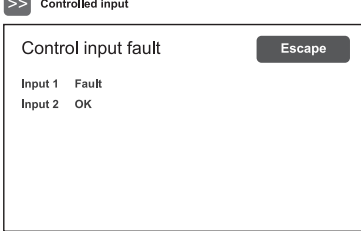
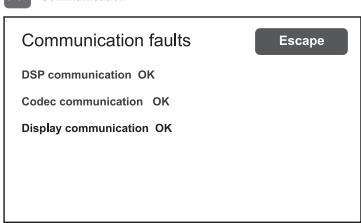
Label	Category subject to diagnosis	See panel	Notes
Power supplies	Primary and secondary power supplies		The diagnosis status is reported for each monitored element.
Control input	Local input contacts		The diagnosis status is reported for each monitored element.
Communication	Internal communication of <b>PAW</b>		The diagnosis status is reported for each monitored element.

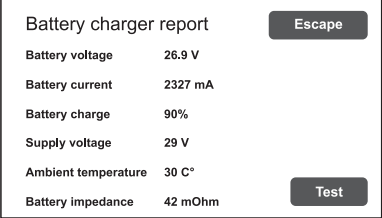
report> BATTERY	Status of batteries
	<p>This panel displays all the data relating to the internal batteries of the <b>PAW</b>.</p> <p>The equipment carries out testing of the batteries automatically approximately once an hour. It is in any case possible to start an immediate test manually by pressing the 'Test' key. If the batteries have not been fitted, the only values detected will be the power supply voltage and the temperature.</p> <p>To return to the INSPECTION menu, press <b>Escape</b>.</p>

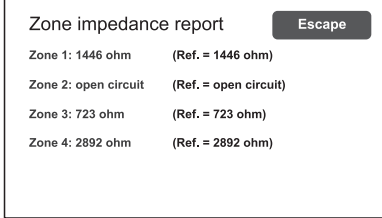
report> IMPEDANCE	Impedance of the lines
	<p>Panel for checking the impedance values measured in real time compared with the value stored during the start-up (see page 36).</p> <p>If the tolerance is exceeded, the fault will be reported in the relevant menu together with a too high, too low or short-circuit impedance value.</p> <p>To return to the INSPECTION menu, press <b>Escape</b>.</p>

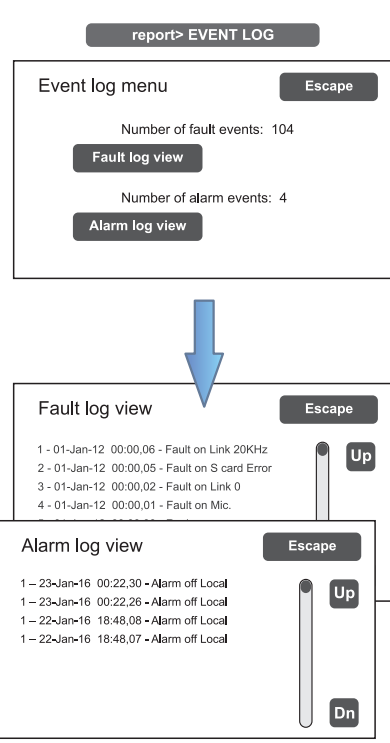
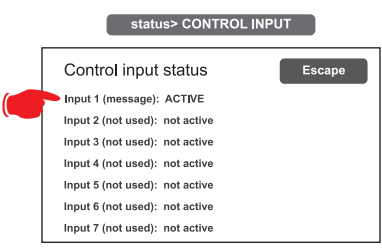
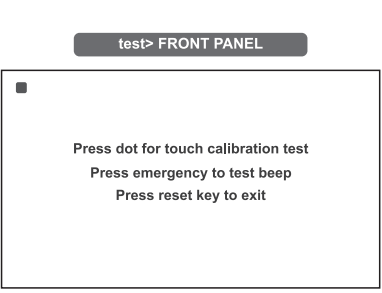
<p><b>report&gt; EVENT LOG</b></p> 	<p><b>Event log</b></p> <p>This panel displays a report showing the total number of faults and alarms recorded during system operation.</p> <p>Press <b>Fault log view</b> for a detailed view of the faults.</p> <p>Press <b>Alarm log view</b> for a detailed view of the alarms.</p> <p>To return to the INSPECTION menu, press <b>Escape</b>.</p>
<p><b>status&gt; CONTROL INPUT</b></p> 	<p><b>Status of the local input contacts</b></p> <p>This panel shows a list of the controlled inputs, their types (message, reset, not used) and their statuses (input active/not active). In the event of activation of one of these inputs, the system will enter an “Alarm status”, light up the ALARM LED and show automatically the panel indicating which <b>PAW</b> zones are affected by the emergency (see under <i>Activation of an automatic emergency</i>, page 46).</p> <p>To return to the INSPECTION menu, press <b>Escape</b>.</p>
<p><b>test&gt; FRONT PANEL</b></p> 	<p><b>Check of operation of the visual and acoustic signalling devices</b></p> <p>Panel for checking operation of the monitor speaker, of the display, of the touch screen and of the signalling LED for the emergency operations. With the exception of the yellow <b>SYS</b> LED, which remains OFF, all the other LEDs and the emergency button will be in the flashing mode. The screen background colour changes in sequence so as to check correct functioning of all the pixels.</p> <p>Press the small black square that appears on the display to check proper calibration of the touch screen.</p> <p>Press the <b>EMERGENCY</b> button to test correct sounding of the “beep” by the monitor speaker as well as button efficiency.</p> <p>To return to the INSPECTION menu, press <b>RESET</b>.</p>

The < OPERATOR> and <CONFIGURATION> keys can be used to go on to the subsequent menus.

## 8.5 <OPERATOR> MENU

### MANAGEMENT OF EMERGENCY, FAULTY AND DISABLED CONDITIONS

Menu from which to select options, to be used only by the personnel in charge of managing the system in the event of an emergency and/or a fault. If a login password was enabled at the time of configuration, the following panel will appear:

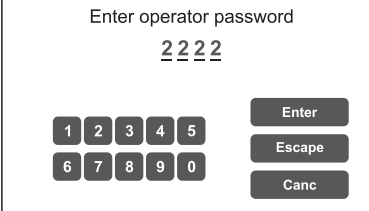

Enter the 4-digit numerical password (it is **2222** by default) and press **Enter**.  
Once the OPERATOR menu is accessed, new items in addition to those already seen will be found.

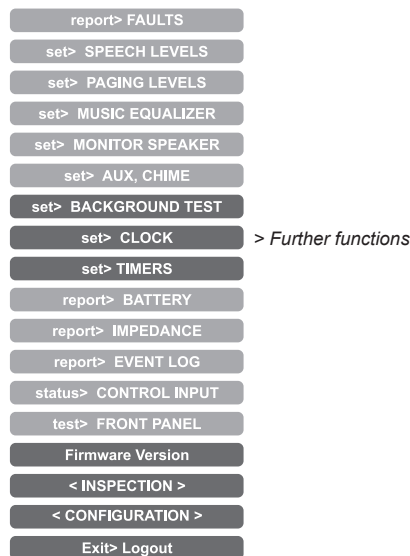

To return to the main screen page press **Main Menu**.

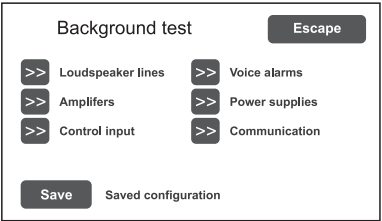
set> BACKGROUND TEST	Enabling and disabling of the monitoring tests
	<p>Panel for enabling and disabling the monitoring tests applied to those items affecting the system functioning in emergency conditions. Select the required item(s) in order to access the relevant sub-panels *. If the parameters of one or more items are changed, press <b>Save</b> to save the new configuration.</p> <p>To return to the OPERATOR menu press <b>Escape</b>.</p> <p>*For details see the table on page 33.</p>

#### Note:

Upon access to the various panels shown below, the touch screen shows the programming status as currently set. To change this status move the cursors to the desired positions – as indicated in the table - and then press '**Save**' on the set> BACKGROUND TEST panel.



Label	Application	See panel	Notes
Loudspeaker lines	Loudspeaker lines		<p>Panel for testing the loudspeaker lines.</p> <p><b>On</b> = test enabled <b>Off</b> = test disabled</p>
Amplifiers	Amplifiers		<p>Panel for testing the local amplifiers.</p> <p><b>On</b> = test enabled <b>Off</b> = test disabled</p>
Control input	Controlled inputs		<p>Panel for testing the input contacts.</p> <p><b>On</b> = test enabled <b>Off</b> = test disabled</p>
Voice alarms	Voice emergency sources		<p>Panel for testing the incoming emergency sources:</p> <ul style="list-style-type: none"> <li>- Testing of handheld micro</li> <li>- Testing of emergency units</li> <li>- Testing messages</li> <li>- Testing Link A</li> <li>- Testing Link B</li> <li>- Testing of remote <b>PAWs</b></li> </ul> <p><b>On</b> = test enabled <b>Off</b> = test disabled</p>
Power supplies	Power supplies		<p>Panel for testing of power supplies:</p> <ul style="list-style-type: none"> <li>- Testing of battery charger</li> <li>- Testing of mains supply</li> <li>- Testing of 24 VDC batteries</li> <li>- Testing of GND fault</li> </ul> <p><b>On</b> = test enabled <b>Off</b> = test disabled</p>
Communication	Internal communication of <b>PAW</b>		<p>Panel for testing of internal data communication of <b>PAW</b>:</p> <ul style="list-style-type: none"> <li>- Testing of DSP comm.</li> <li>- Testing of codec comm.</li> <li>- Testing of display comm.</li> </ul> <p><b>On</b> = test enabled <b>Off</b> = test disabled</p>

<p style="text-align: center;"><b>set&gt; CLOCK</b></p> <div style="border: 1px solid black; padding: 5px; margin-bottom: 10px;"> <p>Clock setting <span style="float: right;">Escape</span></p> <p>Date: 2016 Jul 12, Tue <span style="float: right;">Set date</span></p> <p>Time: 11:20:05 <span style="float: right;">Set time</span></p> <p style="text-align: right;"><span style="float: right;">Set cal.</span></p> </div> <p style="text-align: center; font-size: 2em; color: blue;">↓</p> <div style="border: 1px solid black; padding: 5px; margin-bottom: 10px;"> <p>Date setting <span style="float: right;">Escape</span></p> <p>Year: &lt;&lt; 2016 &gt;&gt;</p> <p>Month: &lt;&lt; Jul &gt;&gt;</p> <p>Day: &lt;&lt; 12 &gt;&gt;</p> <p style="text-align: center;">Save</p> </div> <div style="border: 1px solid black; padding: 5px; margin-bottom: 10px;"> <p>Time setting <span style="float: right;">Escape</span></p> <p>Hour: &lt;&lt; 11 &gt;&gt;</p> <p>Minute: &lt;&lt; 20 &gt;&gt;</p> <p>Second: &lt;&lt; 00 &gt;&gt;</p> <p style="text-align: center;">Save</p> </div> <div style="border: 1px solid black; padding: 5px;"> <p>Clock calibration <span style="float: right;">Escape</span></p> <p>PPM correction <span style="float: right;">0.0</span></p> <p style="text-align: center;">- +</p> <p style="text-align: center;">-- ++</p> <p style="text-align: center;">Save</p> </div>	<p><b>Setting of system date and time</b></p> <p>Panel for setting the system date and time. Press the following buttons:</p> <ul style="list-style-type: none"> <li>- <b>Set date</b> (date)</li> <li>- <b>Set time</b> (hour) and</li> <li>- <b>Set cal.</b> (calibration)</li> </ul> <p>to set these parameters. To return to the OPERATOR menu press '<b>Escape</b>'.</p> <p>After setting the desired date, press 'Save date' before pressing '<b>Escape</b>' to exit.</p> <p>After setting the desired time, press 'Save time' before pressing '<b>Escape</b>' to exit.</p> <p>The <b>Clock Calibration</b> window enables fine setting of the clock. It is advisable to check the difference in seconds compared with a high-precision clock after a couple of days. Calculate the difference in parts per million (over or under) and enter the result by means of the 'PPM correction' keys. Then press '<b>Save</b>' to save the setting. Press '<b>Escape</b>' to exit.</p>
<p style="text-align: center;"><b>set&gt; Firmware Version</b></p> <div style="border: 1px solid black; padding: 5px;"> <p>Firmware versions <span style="float: right;">Escape</span></p> <p>CPU: vers= 1, rel= 0    Build: 14</p> <p>Display: vers= 1, rel= 0</p> <p>DSP: vers= 1, rel= 0</p> <p>Charger: vers= 0, rel= 1</p> <p>Amplifiers 1, 2: vers= 0, rel= 1</p> <p>Amplifiers 3, 4: vers= 0, rel= 1</p> <p>Amplifiers 5, 6: vers= 0, rel= 1</p> <p>Module: vers= 0, rel= 0</p> </div>	<p><b>Viewing the firmware version</b></p> <p>Panel for viewing the version of the firmware installed in the PAW system.</p> <p>To return to the OPERATOR menu press '<b>Escape</b>'.</p>

Use the < **INSPECTION** > and < **CONFIGURATION** > key to access the relevant menus.

**! N.B.:**

**Upon completion of the operations carried out, before returning to the basic level, that is to say to the MUSIC MENU, it is advisable to log out of the system level corresponding to the current menu, so as to reset the required password for future accesses and to prevent unauthorised personnel from accessing the advanced functions of the system**

To do this, select **Exit> Logout** from the list in the OPERATOR menu: the system returns to its basic level and shows the MUSIC MENU panel. The request for the login password will be reset also for any other levels visited. Otherwise, after 5 minutes without any keys being pressed, the system will automatically reset the password.

### 8.6 <CONFIGURATION> MENU

#### MANAGEMENT OF ADVANCED SYSTEM FUNCTIONS AND CONFIGURATION CHANGES

This option selection menu is for use only by specifically trained personnel authorised to work on advanced system functions and to modify the configuration parameters, for system start-up and maintenance purposes. If a login password was enabled at the time of configuration, the following panel will appear:

Enter configuration password

3 3 3 3

1	2	3	4	5	Enter
6	7	8	9	0	Escape
					Canc

Enter the 4-digit numerical password (it is **3333** by default) and press **Enter**.  
Once the CONFIGURATION menu is accessed, additional new items will be seen.

- report> FAULTS
- set> IMP. REFERENCE
- set> 20KHZ LEVELS
- set> MESSAGE LEVELS
- set> ALARM LEVELS
- set> EMERG. LEVELS
- set> ZONE EQUALIZER
- set> MUSIC EQUALIZER
- set> SPEECH LEVELS
- set> PAGING LEVELS
- set> MONITOR SPEAKER
- set> AUX, CHIME
- set> RACK CONFIG.
- set> MESSAGE CONFIG.
- set> LANGUAGE CONFIG.
- set> BACKGROUND TEST
- set> CLOCK
- report> BATTERY
- report> IMPEDANCE
- report> EVENT LOG
- status> CONTROL INPUT
- test> FRONT PANEL
- Firmware Version
- Password
- Beep operation
- < SERVICE >
- Exit> Logout

To return to the main screen, press **Main Menu**.

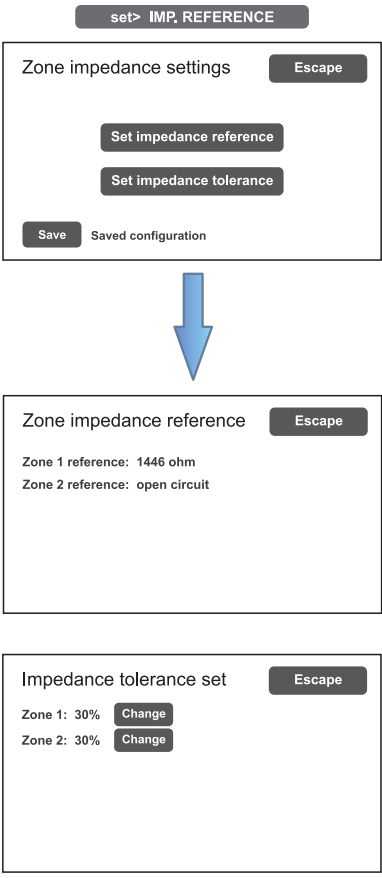
set> IMP. REFERENCE	Impedance acquisition and tolerance setting
	<p>Panel for acquiring line impedance values and setting the tolerance threshold for the diagnostic tests.</p> <p>Press the appropriate buttons to access the sub-panels. Please note that if the new impedance and tolerance values are accepted, they will have to be saved by pressing the <b>'Save'</b> key.</p> <p>The <b>Zone impedance reference</b> panel shows the impedance values measured on the output zones, which will constitute the reference values.</p> <p>Use the <b>Set impedance tolerance</b> panel to define the tolerance, choosing one of the suggested values (press the <b>Change</b> key associated with the desired zone and set one of the following values: 10%, 20%, 30%, 40% or 50%). When the diagnostic system detects a value beyond the tolerance chosen for the reference value, a 'Fault' is activated.</p> <p>To return to the CONFIGURATION menu, press <b>Escape</b>.</p>

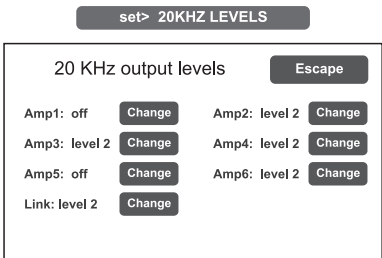
set> 20KHZ LEVELS	Setting the test signal level
	<p>Panel for setting the test signal levels to 20 kHz in the various audio channels. Press the Change keys associated with the level to be adjusted and select one of the following options: <b>level 1</b>, <b>level 2</b>, <b>level 3</b> or <b>Off</b>.</p> <p>The recommended value for the amplifiers is <b>2</b>, while for a link it should be chosen on the basis of the distance between the racks.</p> <p>To return to the CONFIGURATION menu, press <b>Escape</b>.</p>

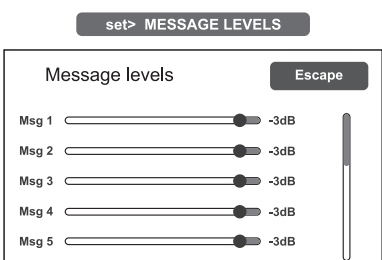
set> MESSAGE LEVELS	Setting message levels
	<p>Panel for setting the levels for the messages stored in the card-cage memory. Move the cursors along the bars to adjust each level.</p> <p>To return to the CONFIGURATION menu, press <b>Escape</b>.</p>

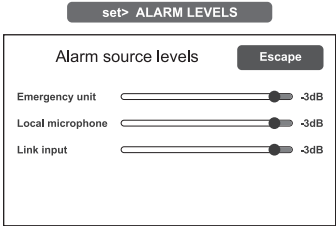
<p><b>set&gt; ALARM LEVELS</b></p>	<p><b>Setting the alarm source level</b></p>
	<p>Panel for setting the output volume of the alarm sources connected to the <b>PAW5500-VES</b>.</p> <ul style="list-style-type: none"> <li>- Emergency units.</li> <li>- Hand-held paging local microphone.</li> <li>- LINK input (connection with other <b>PAWs</b>).</li> </ul> <p>To return to the CONFIGURATION menu, press <b>Escape</b>.</p>

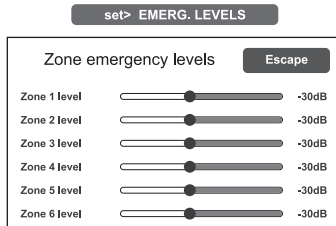
<p><b>set&gt; EMERG. LEVELS</b></p>	<p><b>Setting the zone volume level during emergencies</b></p>
	<p>Panel for adjusting the zone volume during emergencies.</p> <p>To return to the CONFIGURATION menu, press <b>Escape</b>.</p>

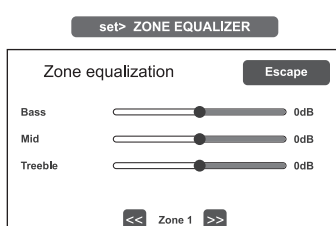
<p><b>set&gt; ZONE EQUALIZER</b></p>	<p><b>Equalisation of the zone tones</b></p>
	<p>Panel for equalising the bass, mid-range and treble tones in each output zone.</p> <p>To return to the CONFIGURATION menu, press <b>Escape</b>.</p>

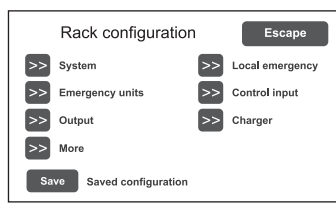
<p><b>set&gt; RACK CONFIG.</b></p>	<p><b>Rack configuration</b></p>
	<p>This panel contains all the parameters needed for configuring the rack:</p> <ul style="list-style-type: none"> <li>- System.</li> <li>- Emergency messages to broadcasting zones.</li> <li>- Emergency unit.</li> <li>- Controlled inputs.</li> <li>- Outputs.</li> <li>- Battery charger.</li> <li>- Selection of optional cards / Local broadcasting unit.</li> </ul> <p>Note that any changes whatsoever to any of the sub-panels illustrated on the following page must be saved by pressing the <b>Save</b> button.</p> <p>To return to the CONFIGURATION menu, press <b>Escape</b>.</p>

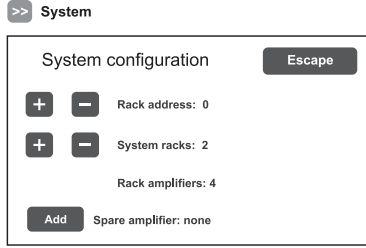
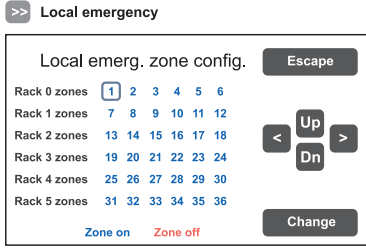
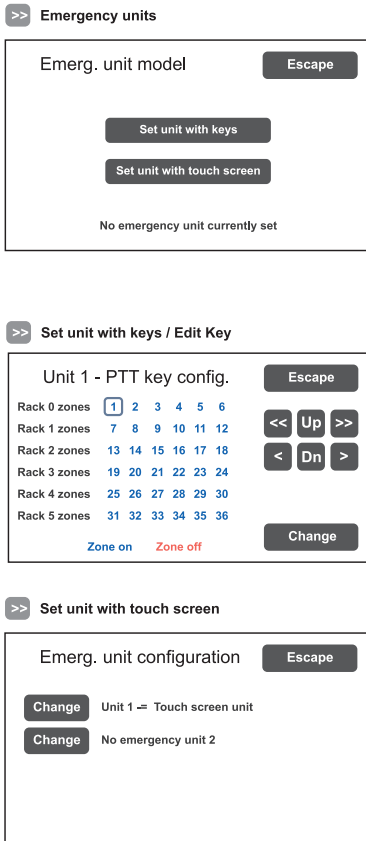
Label	Application	See panel	Notes
System	System configuration Standby amplifier	 <p>&gt;&gt; System</p> <p>System configuration <span>Escape</span></p> <p><span>+</span> <span>-</span> Rack address: 0</p> <p><span>+</span> <span>-</span> System racks: 2</p> <p>Rack amplifiers: 4</p> <p><span>Add</span> Spare amplifier: none</p>	<p>In this panel the following are set:</p> <ul style="list-style-type: none"> <li>- <b>PAW</b> ID address (0 to 5).</li> <li>- Number of <b>PAWs</b> in the system.</li> <li>- Attribution of standby amplifier.</li> </ul> <p>The total number of amplifiers present in the system is also shown automatically.</p>
Local emergency	Local emergency	 <p>&gt;&gt; Local emergency</p> <p>Local emerg. zone config. <span>Escape</span></p> <p>Rack 0 zones <span>1</span> 2 3 4 5 6</p> <p>Rack 1 zones 7 8 9 10 11 12</p> <p>Rack 2 zones 13 14 15 16 17 18</p> <p>Rack 3 zones 19 20 21 22 23 24</p> <p>Rack 4 zones 25 26 27 28 29 30</p> <p>Rack 5 zones 31 32 33 34 35 36</p> <p>Zone on Zone off <span>Change</span></p> <p><span>Up</span> <span>Dn</span> <span>&lt;</span> <span>&gt;</span></p>	<p>Panel for setting the default broadcasting zones for emergency messages. The situations of all the <b>PAWs</b> present in the system is shown. Use the Up and Dn and arrow keys to move through the table. For the remote racks, the values selected refer to all the zones.</p> <p>Press 'Change' to change the zone status, choosing between:</p> <ul style="list-style-type: none"> <li>blue = active zone and</li> <li>red = inactive zone</li> </ul> <p>To leave this screen, press 'Escape'.</p>
Emergency units	Emergency units	 <p>&gt;&gt; Emergency units</p> <p>Emerg. unit model <span>Escape</span></p> <p><span>Set unit with keys</span></p> <p><span>Set unit with touch screen</span></p> <p>No emergency unit currently set</p> <p>&gt;&gt; Set unit with keys / Edit Key</p> <p>Unit 1 - PTT key config. <span>Escape</span></p> <p>Rack 0 zones <span>1</span> 2 3 4 5 6</p> <p>Rack 1 zones 7 8 9 10 11 12</p> <p>Rack 2 zones 13 14 15 16 17 18</p> <p>Rack 3 zones 19 20 21 22 23 24</p> <p>Rack 4 zones 25 26 27 28 29 30</p> <p>Rack 5 zones 31 32 33 34 35 36</p> <p>Zone on Zone off <span>Change</span></p> <p><span>&lt;&lt;</span> <span>Up</span> <span>&gt;&gt;</span></p> <p><span>&lt;</span> <span>Dn</span> <span>&gt;</span></p> <p>&gt;&gt; Set unit with touch screen</p> <p>Emerg. unit configuration <span>Escape</span></p> <p><span>Change</span> Unit 1 = Touch screen unit</p> <p><span>Change</span> No emergency unit 2</p>	<p>From this panel it is possible to use the sub-menus to set the configurations of the emergency units connected to the <b>PAW</b>.</p> <p>To configure the <b>PMB132</b> range emergency units, press '<b>Set unit with keys</b>', then press the '<b>Change</b>' key to select the model.</p> <p>Then press '<b>Edit key</b>' for configuring the keys. Use the '&lt;&lt;' and '&gt;&gt;' keys to pass from one key to another of the unit. Move over the table using the &lt; and &gt; keys and the Up/Dn keys. Press '<b>Change</b>' to change the association of the zone with the key, choosing between:</p> <ul style="list-style-type: none"> <li>Blue = Zone associated</li> <li>Red = Zone not associated</li> </ul> <p>To leave the screen, press 'Escape'.</p> <p>The item '<b>Set unit with touch screen</b>' refers to the presence of the <b>TSB8500-V</b> touch screen unit.</p>

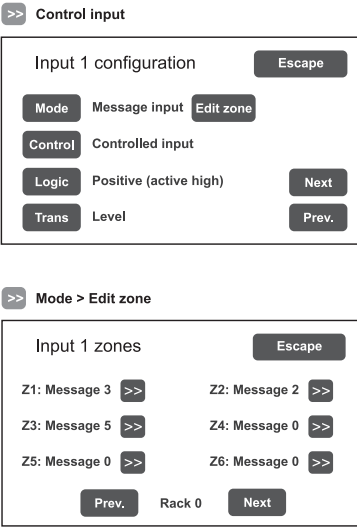
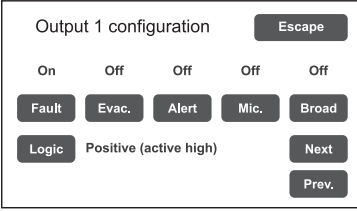
Label	Application	See panel	Notes
Control input	Controlled input contacts		<p>Panel for configuring the controlled inputs. To go from one input to another (from 1 to 7), press <b>Next</b> or <b>Prev</b>.</p> <p>Press <b>Mode</b> to select one of the following modes:            - <b>Message input &gt; Edit zone</b>            - <b>Broadcast &gt; Edit zone</b>            Press '<b>Edit zone</b>' to associate a message with each zone            - <b>Not active input</b>            - <b>Reset input</b></p> <p>Press <b>Control</b> to enable or disable control over the concerned input.</p> <p>Press <b>Logic</b> to set the logic typology attributed to the concerned input, choosing between:            - <b>Positive</b> (active high)            - <b>Negative</b> (active low)</p> <p>Press <b>Trans</b> to choose the operating mode:            - <b>Level</b>: the messages are activated only for as long as the input is activated.            - <b>Transition</b>: activation of the messages starts with activation of the input, but can be stopped only by means of manual resetting or a reset input.</p> <p>Press <b>Priority</b> to select the level of priority of transmission from the broadcast messenger</p> <p>Press '<b>Escape</b>' to exit the screen page.</p>
Output	Relay outputs		<p>Panel for configuring the outputs. To go from one output to another (from 1 to 3), press <b>Next</b> or <b>Prev</b>. Activate or de-activate (On/Off) the type of event to be associated with the output in question by pressing the appropriate buttons.</p> <p>To leave the screen, press '<b>Escape</b>'.</p>

Label	Application	See panel	Notes																		
More	Selection of optional cards Local broadcasting unit	<p>The 'Other configurations' panel shows 'Optional cards' and 'Local unit config.' with right arrow keys. The 'Optional cards' panel shows '6 input card' with a right arrow key. The 'Local unit config.' panel shows four 'Local unit address' settings (1-4) with 'On' or 'Off' toggle switches.</p>	<p>Panel enabling two selections to be made:</p> <ul style="list-style-type: none"> <li>- <i>Optional cards</i></li> <li>- <i>Local unit config.</i></li> </ul> <p>On the 'Optional cards' screen, press the &gt;&gt; key to select and enable the optional card, if any, present in the system (<b>ACPAW-2IN</b> or <b>ACPAW-6IN</b>).</p> <p>On the 'Local unit config.' screen, slide the cursors to select up to 4 broadcast stations to be used in the local mode (included among the 16 that are permitted). On activating this function, keys 1 to 6 of the station will correspond, in the same order, to the zones of the card-cage to which the station itself is connected (e.g. if the local base is connected to card-cage 2, key 1 will correspond to zone 13, key 2 to zone 14 and so on). It is advisable to use Paso <b>PMB106-G</b> units as local stations.</p>																		
Charger	Battery charger	<p>The 'Charger configuration' panel shows 'Battery capacity: 40 Ah' and 'Energy save enabled' with 'Change' buttons. Below the panel, there are two tables for charging capacity and duration.</p> <p><b>2 AMP (Pmax = 250W)</b></p> <table border="1"> <thead> <tr> <th>Capacity</th> <th>Duration without mains supply</th> </tr> </thead> <tbody> <tr> <td>18 Ah</td> <td>24 h + 30 min*</td> </tr> <tr> <td>26 Ah</td> <td>35 h + 30 min</td> </tr> <tr> <td>33 Ah</td> <td>44 h + 30 min</td> </tr> <tr> <td>40 Ah</td> <td>72 h + 30 min</td> </tr> </tbody> </table> <p><b>4/6 AMP (Pmax = 500W)</b></p> <table border="1"> <thead> <tr> <th>Capacity</th> <th>Duration without mains supply</th> </tr> </thead> <tbody> <tr> <td>26 Ah</td> <td>24 h + 30 min*</td> </tr> <tr> <td>33 Ah</td> <td>30 h + 30 min</td> </tr> <tr> <td>40 Ah</td> <td>36 h + 30 min</td> </tr> </tbody> </table>	Capacity	Duration without mains supply	18 Ah	24 h + 30 min*	26 Ah	35 h + 30 min	33 Ah	44 h + 30 min	40 Ah	72 h + 30 min	Capacity	Duration without mains supply	26 Ah	24 h + 30 min*	33 Ah	30 h + 30 min	40 Ah	36 h + 30 min	<p>Battery configuration panel.</p> <p>By pressing 'Change' it is possible to set:</p> <ul style="list-style-type: none"> <li>- The capacity of the battery (choose 18, 26, 33 or 40 Ah).</li> <li>- 'Energy save' mode enabled/disabled. This enables the batteries to remain in the energy saving mode when there is no mains power.</li> </ul> <p>*According to UNI ISO 7240-19 point 5.15.3 requirements: 24 h standby plus 30 minutes in vocal alarm condition.</p>
Capacity	Duration without mains supply																				
18 Ah	24 h + 30 min*																				
26 Ah	35 h + 30 min																				
33 Ah	44 h + 30 min																				
40 Ah	72 h + 30 min																				
Capacity	Duration without mains supply																				
26 Ah	24 h + 30 min*																				
33 Ah	30 h + 30 min																				
40 Ah	36 h + 30 min																				

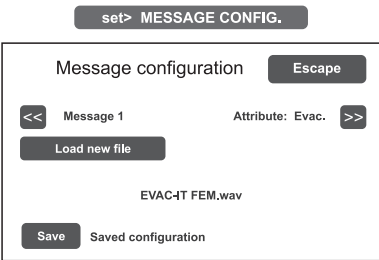

<p><b>set&gt; MESSAGE CONFIG.</b></p> 	<p><b>Setting of emergency messages</b></p> <p>The default messages (Alert, Evacuation and warning signal/chime) are stored in the PAW5500-VES internal flash memory. To further customise the system, it is also possible to load customised WAV files from external devices (an SD card or USB memory stick). To do this, it is necessary to:</p> <ul style="list-style-type: none"> <li>- Use the &lt;&lt; and &gt;&gt; keys to select the message to be loaded.</li> <li>- Press '<b>Load new file</b>' to go and select the file in the SD card or on the USB stick in the specific search window.</li> <li>- Select the file by pressing '<b>Select</b>' and then confirming with '<b>OK</b>'. The display will show the stages of cancellation of the old contents followed by recording of the new message, played out at the same time via the monitor loudspeaker. Upon completion the 'Message configuration' screen will reappear.</li> </ul> <p><b>Message attributes:</b></p> <p><b>Evac:</b> the message is considered an evacuation message and therefore has a higher priority than an alert.</p> <p><b>Alert:</b> the message is considered an alert and therefore has a lower priority than an evacuation message.</p> <p><b>Broadcast:</b> this is a general announcement, suppressed in emergency conditions. It is used associated with a broadcast input with the related priority.</p> <p><b>None:</b> The message is not used.</p> <p>To change the attribute of a message, use the 'Change' key.</p> <p><i>N.B.: Messages 1 and 2 have fixed attributes, that is to say EVAC and ALERT respectively. It is compulsory for the system to have at least these two messages, which can be called up from local and remote stations. All the messages with the attributes EVAC or ALERT are subjected to checksum tests and in the event of an error their failure is signalled.</i></p> <p>To return to the CONFIGURATION menu, press <b>Escape</b>.</p>
---	---

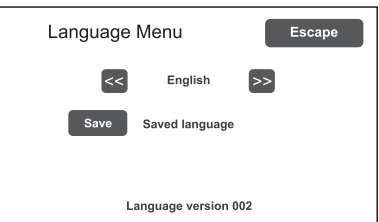
<p><b>set&gt; LANGUAGE CONFIG.</b></p> 	<p><b>Selecting the language</b></p> <p>The factory-set default language is English. The new PAW5500-VES range enables other languages, pre-installed and stored in the internal flash memory, to be chosen.</p> <p>Use the &lt;&lt; and &gt;&gt; keys to browse through the available languages. When the required language is shown, press <b>Save</b>. The new menus will be loaded immediately and the MUSIC screen page will reappear on the display.</p> <p>To return to the CONFIGURATION menu, press <b>Escape</b>.</p>
--	---

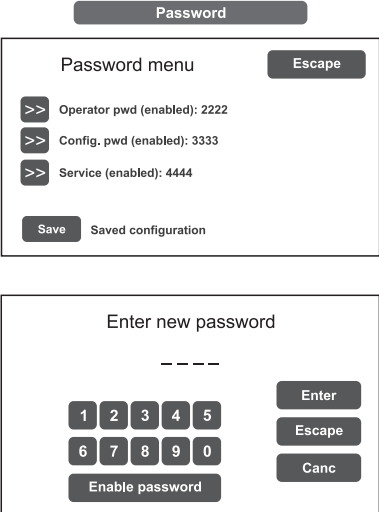
Password	Setting a password
	<p>Panel for enabling, disabling and customising the password for logging into the system service levels. The default passwords set are those shown here on the left. To change these settings and enter a new code, press the key associated with the menu in which the change is to be made and, on the next sub-panel, enter the new password.</p> <p>To correct a typing error, use the <b>Canc</b> key.</p> <p>To enable / disable a password, use the <b>Enable password</b> or <b>Disable password</b> keys (as the case may be).</p> <p>Press <b>Enter</b> to confirm and return to the Password menu panel.</p> <p>Press <b>Save</b> to save the change made.</p> <p>To return to the CONFIGURATION menu press <b>Escape</b>.</p>

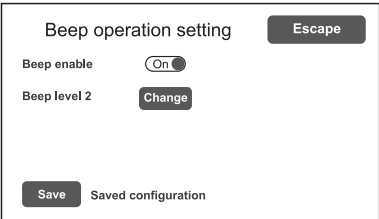
Beep operation	Set the control 'beep'
	<p>From this screen, the acoustic fault (conventionally known as a 'beep') can be set.</p> <ul style="list-style-type: none"> <li>- <b>Beep enable / disable:</b> Move the cursor to the 'On' position (beep enabled) or to the 'Off' position (beep not enabled), as needed (see the "N.B" note below).</li> <li>- <b>Beep level:</b> Adjustment of the beep volume, which can be set at one of three different levels (1 / 2 / 3 / Off). Press the <b>Change</b> key until the desired volume is reached.</li> </ul> <p>To return to the CONFIGURATION menu, press <b>Escape</b>.</p> <p><b>! N.B.</b> <b>In order to comply with the regulations, before using the equipment for normal operation it is necessary to enable the acoustic signalling by setting 'Beep enable' to the 'On' position.</b></p>

#### IMPORTANT NOTE!

##### <SERVICE> MENU [FOR TECHNICAL ASSISTANCE OPERATORS ONLY]

Fourth access level, included in the CONFIGURATION menu options. **Its use is permitted only to those members of the technical service personnel who have appropriate login passwords.**

## 8.7 CRITERIA FOR MANAGING PRIORITIES IN EMERGENCY CONDITIONS

THE SYSTEM MANAGES EMERGENCY CONDITIONS ON THE BASIS OF TWO CRITERIA:

### 8.7.1 MANAGEMENT OF PRIORITIES ON THE BASIS OF HOW EMERGENCIES ARE ACTIVATED

There are two possible types of activation:

**MANUAL EMERGENCY:** emergency state activated by the operator by means of the LED pushbutton on the card-cage local controls or on the emergency microphone stations.

**AUTOMATIC EMERGENCY:** emergency state activated from control inputs.

Depending on the management system, it is possible that only one operator can activate a MANUAL EMERGENCY; in this case, the local controls of the card-cages have maximum priority.

In a system with more than one card-cage, the first card-cage to activate the emergency has priority.

The emergency stations follow in the order of priorities, on the basis of the level set on the base itself.

The AUTOMATIC EMERGENCY condition, on the other hand, is always in addition to the MANUAL EMERGENCY, if any, and, if necessary, it can be excluded by the latter.

### 8.7.2 MANAGEMENT OF PRIORITIES OF ALARM MESSAGES

When different alarm messages are called up on a given zone from different sources (local controls, remote microphone stations, control inputs and remote card-cages), the system will choose the message to be sent out depending on how the priorities are managed. The order of priority is indicated below, starting from the highest priority down to the lowest:

1. Handsfree messages from a local unit/ remote station / remote control unit (in this case all pre-recorded messages will be muted).
2. EVACUATION message (message 1) activated by a MANUAL EMERGENCY.
3. ALERT message (message 2) activated by a MANUAL EMERGENCY.
4. Message 1 activated by an AUTOMATIC EMERGENCY.
5. Messages numbered from 3 to 8 in this order, with the EVAC attribute activated by an AUTOMATIC EMERGENCY.
6. Message 2 activated by an AUTOMATIC EMERGENCY.
7. Messages numbered from 3 to 8 in this order, with the ALERT attribute activated by an AUTOMATIC EMERGENCY.

## 8.8 MANUAL EMERGENCY

THE PROCEDURE FOR MANAGING EMERGENCIES IN THE MANUAL MODE (TO BE CARRIED OUT BY AN AUTHORIZED OPERATOR) IS DESCRIBED BELOW.

### 8.8.1 GENERAL INFORMATION

The manual emergency mode can be accessed at any time and has priority both over any pre-recorded messages under way - that may have been activated by an external peripheral unit connected to the controlled inputs (9) – and over any emergency units able to function on the output lines from the **PAW** being used.

### 8.8.2 MANUAL MANAGEMENT OF AN EMERGENCY

The **PAW** enables structured management of alarm messages, of their muting and of the selection of zones, as described in greater detail below. Following is a list of operations for a fast approach to manual emergencies.

#### 8.8.3 SENDING OUT OF A LIVE EMERGENCY NOTICE FROM THE PAW

- 1) Lift the safety lid and press the **EMERGENCY** key (5) once. It lights up steadily. The display shows the **PAW** output zones. The fact that the system has been placed in a state of emergency is shown simultaneously on any stations and **PAWs** present in the system.

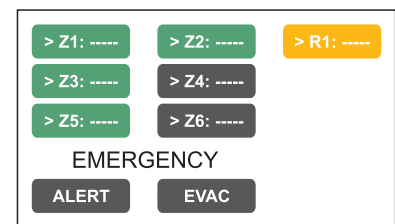

- 2) **To send:**

**A voice message** > Select the desired zones and racks, then use the hand-held microphone (3) to speak, keeping the button on its side pressed.

**A pre-recorded ALERT message** > Select the desired zones and racks and press ALERT.

**A pre-recorded EVACUATION message** > Select the desired zones and racks and press EVAC.

In both cases, the keys on the display will show the type of message being broadcast in each zone.

#### Note:

If the PTT key of the hand-held microphone or the ALERT or EVAC keys are pressed without selecting any zones beforehand, the message will be sent out as set at the time of system configuration (see **set> RACK CONFIG. > Local emergency** on page 38). The zones selected at the configuration stage are highlighted by the marker '>' on the keys.

Any faulty zones or racks are shown by the yellow colour of the concerned key.

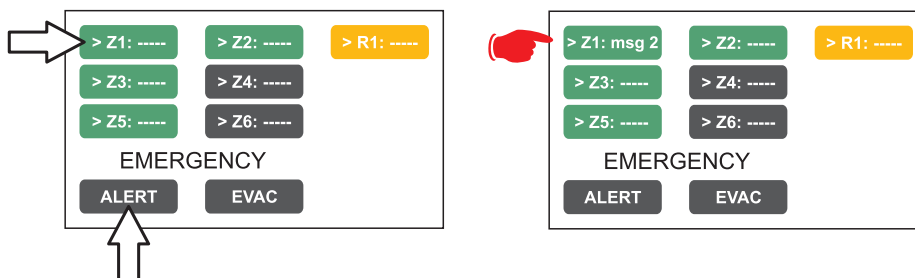

#### Note:

**A message sent via the hand-held microphone has top priority over the pre-recorded evacuation and alert messages. In the event of simultaneous selection, an EVAC message always has priority over an ALERT message.**

- 3) To end the state of emergency, press the **EMERGENCY** key (5) again.

#### 8.8.4 SENDING OUT OF A LIVE EMERGENCY NOTICE FROM REMOTE STATIONS

- 1) Lift the safety lid on the station and press the **EMERGENCY** key once. It lights up steadily. The fact that the system has been placed in a state of emergency by the station is shown also on any other stations and on the **PAWs** linked to the system (with a flashing key).
- 2) Select the zones where the message should be sent.
- 3) Activate the EVAC message or the ALERT message by means of the appropriate button or speak through the microphone keeping the PTT key pressed until the end of the message.

**Note: The PTT key has priority over any pre-recorded messages being sent out.**

- 4) If necessary, repeat the sequence of points **2)** and **3)** above several times.
- 5) To end the state of emergency, press **EMERGENCY** button again.

#### 8.8.5 EXIT OF THE SYSTEM FROM MANUAL MANAGEMENT OF AN EMERGENCY

At the end of the procedure for managing a Manual Emergency, press the red EMERGENCY key, which will extinguish and – if there is no activation taking place from external peripheral units connected to the controlled input contacts – the system will return automatically to its Idle state, displaying the MUSIC MENU.

The ALARM LED will extinguish to indicate that the VOICE ALARM has been deactivated.

If, on the other hand, any of controlled inputs have been activated, the EMERGENCY button will start to flash and the system will remain in a state of Automatic Emergency, resuming the broadcasting of the messages in the various areas, depending on how the activated inputs were programmed.

## 8.9 AUTOMATIC EMERGENCY –ALARM STATUS ACTIVATED BY AN EXTERNAL PERIPHERAL UNIT

THE PROCEDURE FOR MANAGING AN EMERGENCY STATUS SET OFF BY AN EXTERNAL PERIPHERAL UNIT THAT ACTIVATES THE INPUT CONTACTS PROGRAMMED TO ENABLE THE “ALARM STATUS” IS DESCRIBED BELOW.

### 8.9.1 ACTIVATION OF AN AUTOMATIC EMERGENCY

In the event of activation of a programmed input contact the **PAW** stops its 'Idle' state normal activity, mutes the music being broadcast, inhibits operation of the PA sources for broadcasting announcements and shows the AUTOMATIC EMERGENCY screen, which indicates the type of message being sent out to the zones:

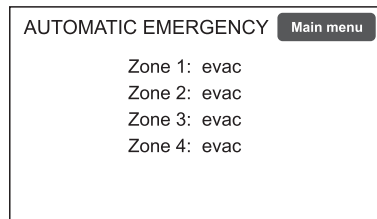

To see rapidly which input is activating the emergency, press the **Main Menu** key to return to the main panel, then go to the **INSPECTION** menu and select the item **status> CONTROL INPUT**:

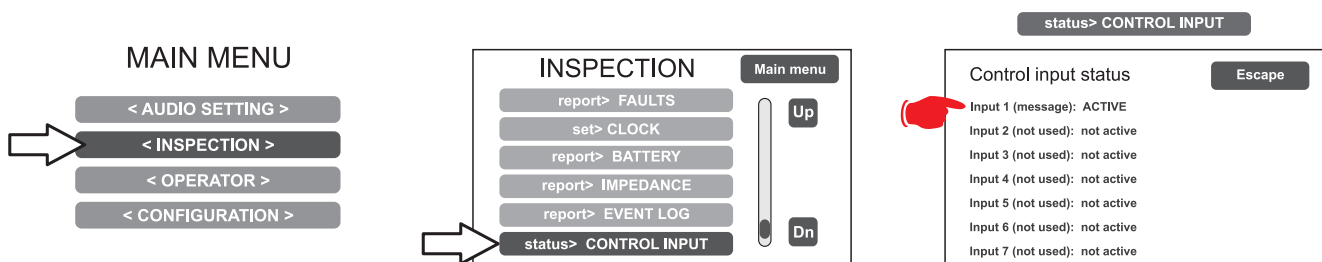

### 8.9.2 VIEWING THE OPERATIONAL STATUS

The condition of active VOICE ALARM - live announcement via the microphone or pre-recorded message under way - is shown by the red ALARM LED lighting up on the front panel of the PAW.

### 8.9.3 SYSTEM OPERATION DURING AN AUTOMATIC EMERGENCY

As long as the input contacts remain active, the MUSIC MENU panel continues to be deactivated, however it is in any case possible to navigate through the various menus containing options for accessing advanced system functions and to inspect or change their settings.

The current “Alarm Status” due to the Automatic Emergency can be changed by an authorised operator, who can take steps to activate the manual controls for managing the system emergency in order to mute the messages by holding the RESET key down for at least 2 seconds, to change those under way or to send out live announcements with the microphone.

For details concerning the **Manual Emergency** mode, see the appropriate section (page 44).

### 8.9.4 EXITING FROM AN AUTOMATIC EMERGENCY

Exit from an Automatic Emergency takes place when no input contact is active.

The system will return to the 'Idle State', displaying the MUSIC MENU panel.

## 9. FAILURE STATUS

THE PAW5500-VES HAS DIAGNOSTIC ROUTINES THAT MONITOR CONTINUOUSLY THE AVAILABILITY OF EMERGENCY SOURCES AND THE INTEGRITY OF CRITICAL PATHS OF THE SIGNALS ENSURING SYSTEM OPERATION IN EMERGENCY CONDITIONS.

### 9.1 SYSTEM OPERATION AND SIGNALLING IN A GENERIC FAILURE CONDITION

#### • SYSTEM SIGNALLING DUE TO AN EXISTING “FAILURE CONDITION”

When the monitoring system detects a fault during the normal “Idle State” operation, it promptly activates signalling of the “Failure Condition” as follows:

- the FAULT LED lights up (visual signalling).
- sending out of a beep by the monitor speaker (acoustic signal).
- activation of the local output contacts, if programmed to send signals to an external peripheral unit.
- location of the fault (FAULT): the faulty device and the type of fault are shown on the menu pages under the item **report> FAULTS**.

#### • SYSTEM SIGNALLING FOR RESUMPTION FOLLOWING A “FAILURE CONDITION”

If the cause of the fault no longer exists, the system resumes automatically its “Idle State”, deactivating all the above signalling and storing the information concerning the last fault. The word RESUMED is shown in the menu pages under the item **report> FAULTS** referred to operation of the device that was previously faulty.

#### • CANCELLING THE ACOUSTIC FAULT SIGNALLING AND OPERATION RESUMPTION SIGNALLING

To cancel the acoustic signalling of a current fault:

- go to the INSPECTION, OPERATOR or CONFIGURATION menus.
- press the **RESET** button briefly to halt the beep.

To cancel the signalling of the fault of which a report has been stored and that no longer exists (operation has been RESUMED), there must be no faults under way or the beep must already have been stopped. Therefore:

- go to the INSPECTION, OPERATOR or CONFIGURATION menus.
- press the RESET button briefly to reset all the signalling of faults after which operation has been resumed.

**Note:** In the event of a fault of a loudspeaker line due to a short circuit, once the line has been repaired, it is necessary to carry out a MANUAL RESET in order to re-activate the audio signal on the output of the concerned line:

- Go to the OPERATOR menu or to the CONFIGURATION menu.
- Select the **report> FAULTS** menu followed by **>>Loudspeaker line**. Then, on the ‘**Fault zone impedance report**’ screen, press the RESET key and hold it down for at least two seconds

### 9.2 SYSTEM OPERATION AND SIGNALLING WITH A FAULT ON A LOUDSPEAKER LINE

A fault on a loudspeaker line may be due to any of several causes, such as high impedance, low impedance or a short circuit. If it is a matter of a change in the impedance, the **PAW** continues to send out the zone output audio signal. If, on the other hand, there is a short circuit, the system will disconnect the faulty line of the zone and continue to send out the audio signal on the other line of the same zone (if this is arranged at the time of installation).

## 10. TECHNICAL SPECIFICATIONS

MODEL	PAW5502-V	PAW5504-V	PAW5506-V
Rated audio output @230VAC *typical distortion at 25 W 0,025%	500 W / D=2,5%*		
Rated audio output @24VDC *typical distortion at 25 W 0,025%	400 W / D=10%*		
Display	4.3" backlit with touch screen 480x272 pixels		
N° of PAW5500-VES/x per system	Max 6 (ID 0÷5)		
N° of zones/amplifiers	2	4	6
<b>Inputs</b>			
<b>Emergency microphone</b> • Sensitivity / Impedance • Frequency response • S/N ratio	<b>Balanced XLR-F on the front door</b> Signal level 20 mV / 10 kΩ 60 ÷20.000 Hz 72 dB		
<b>Paging units (BROAD.)</b> • Sensitivity / Impedance • Frequency response • S/N ratio	<b>1 off Rj45 for PMB106/112 paging units (PA)</b> Signal level max. 1400 mV / 85 kΩ 60 ÷20.000 Hz 83 dB		
<b>Emergency units (EMERG.)</b> • Sensitivity / Impedance • Frequency response • S/N ratio	<b>1 off Rj45 for Serie PMB132 or TSB8500-V emergency microphone units</b> Signal level max. 1400 mV / 85 kΩ 60 ÷20.000 Hz 83 dB		
<b>AUX (LINE-VOX)</b> • Sensitivity / Impedance • Frequency response • S/N ratio	<b>Balanced with terminals (HOT-COM-GND)</b> <b>Programmable in ON / OFF / VOX with A.P.T. modes</b> <b>Precedence input with contact closing activation</b> 134 mV / 31 kΩ 90 ÷ 20.000 Hz 81 dB / 85 dBA		
<b>MUSIC / EXT</b> • Sensitivity / Impedance • Frequency response • S/N ratio	<b>Balanced with terminals (HOT-COM-GND)</b> 134 mV / 31 kΩ 90 ÷ 20.000 Hz 81 dB / 85 dBA		
<b>Equalisation</b>			
Independent equalisation for each output zone	<b>3-band equaliser</b> Bass tones (100 Hz): ± 10 dB		
Independent equalisation for each music input	Mid-range (1 kHz): ± 10 dB Treble tones (10 kHz): ± 10 dB		
<b>Outputs</b>			
<b>Constant voltage outputs With double lines (A/B)</b> <i>One zone output can be configured as a standby for the others.</i>	<b>2 zones for 100V lines</b> Minimum 40 Ω	<b>4 zones for 100V lines</b> Minimum 40 Ω	<b>6 zones for 100V lines</b> Minimum 40 Ω
<b>REMOTE LINK</b> • Output level / Impedance • Sensitivity / Input impedance	<b>n°2+2 Rj45 for connection with another PAW5500-VES unit</b> 1 V / 400 Ω 3600 mV / 3 kΩ		
<b>Emergency controls</b> • Controlled inputs <b>CONTACT</b> • Outputs <b>R1, R2, R3</b>	<b>Programmable for normally active or normally inactive state</b> 7 off inputs with diagnostic 3 off relays for signalling, state of emergency and faults (24 Vdc / 1 A each) <i>N.O.-N.C-Exchange state</i>		



MODEL	PAW5502-V	PAW5504-V	PAW5506-V
<b>General information</b>			
Mains power supply @230VAc Consumption @230VAc	230 VAC 50/60Hz +10/-15%  646 W full load (2amp active)  36 W no load	230 VAC 50/60Hz +10/-15%  653 W full load (2amp active / 2amp stand-by)  47 W no load	230 VAC 50/60Hz +10/-15%  660 W full load (2amp active / 4amp stand-by) Efficiency: 75,6% 58 W no load
Secondary power supply @24 Vdc (26,3 Vdc) Secondary power supply Consumption @24 Vdc	20 A full load  0,92 A no load / quiescent 0,3 A no load / energy saving	20 A full load  1,22 A no load / quiescent 0,3 A no load / energy saving	20 A full load  1,5 A no load / quiescent 0,3 A no load / energy saving
<b>Batteries</b>	Suggested value: 26÷28 Ah It is possible to use other batteries (18 Ah - 33 Ah - 40 Ah / see page 40).		
<b>Charger / Power supply unit</b>	8 A (I max. a) 12 A (I max. b) 21 V (final voltage – detached battery) 27,2 V (complete load voltage)		
Environmental operating conditions	Temperature: +5°C ÷ +40°C Relative humidity: 25% to 75% (non-condensing)		
Type of mounting	Wall / To 19" rack with ACPAW-RCK optional accessory		
Dimensions (L x H x P)	430 x 620 x 240 mm		
Net weight (without batteries)	20 kg		

**LIST OF OPTIONAL FUNCTIONS**

CLAUSE	DESCRIPTION
7.6.2	Manual muting of voice alarm condition
7.7.2	Manual resetting of voice alarm condition
7.9	Output for signalling a voice alarm condition
8.3	Indication of fault affecting the transmission paths
8.4	Indication of fault affecting the alarm zones
10	Manual control of voice alarms
11	Interface for external control device(s)
12	Emergency microphone(s)
13.14	Redundant power amplifier

**LIST OF THE AUXILIARY FUNCTIONS**

DESCRIPTION
Broadcast calls
Background music



A series of horizontal dotted lines spanning the width of the page, providing a guide for handwriting practice. The lines are evenly spaced and extend from the left margin to the right margin.



0068

**PASO S.p.A.**

Via Settembrini, 34 - 20020 Lainate (MI) - ITALIA

18

**0068/CPR/101-2018**

**EN54-4:1997 + A1:2002 + A2:2006  
EN 54-16:2008**

Voice alarm control and indicated equipment for fire detection  
and fire alarm systems for buildings

**PAW5502-V | PAW5504-V | PAW5506-V**

Provided options:

- 7.6.2 Manual silencing of the voice alarm condition
- 7.7.2 Manual reset of the voice alarm condition
- 7.9 Voice alarm condition output
- 8.3 Indication of fault related to the transmission path to the CIE
- 8.4 Indication of fault related to voice alarm zone
- 10 Voice alarm manual control
- 11 Interface to external control device(s)
- 12 Emergency microphone(s)
- 13.14 Redundant power amplifier

**pasos** S.p.A.

Via Settembrini, 34 - 20020 Lainate (MI) - Italia  
Tel. +39 0258077.1 • Fax +39 0258077.277  
<http://www.paso.it> E-mail: [info@paso.it](mailto:info@paso.it)

UDT 06/18 | 11/826 | EN